

Features

- NEMA C Frame
- High speed digital pulse train
- Kits include mounting ring, hardware, magnet wheel, and sensor
- Easy to retrofit
- Impervious to dust, oil, and water
- 60 or 120 pulses per revolution
- NPN open collector and line driver options



Description

Electro-Sensors digital ring kits provide digital feedback from motors with NEMA C face end bells, can generate pulses down to zero speed, and transmit—without amplification—up to 1,500 feet. This is an ideal pulse generator for speed monitoring, motor control, counting, process control, cut-to-length, and ratio/draw controlling applications.

The DRK series ring kits can be quickly and easily installed on NEMA C face motors or between a motor and gear box. Each kit features a non-contacting digital pulse generator system.

The QDRK quadrature ring kit provides a 60-pulse per revolution quadrature signal for use with electronic control equipment requiring rotational-direction information. Two signals, 90° out-of-phase, are produced by the sensor. When the leading edge of 'Output A' precedes the leading edge of 'Output B', shaft rotation is forward. When the opposite is true, the monitored shaft is rotating in reverse.

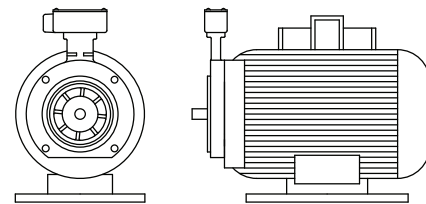

Part No.	Fits NEMA Frame	Shaft Size
(Q)DRK-56C	56C	.5/8"
(Q)DRK-143TC	143TC, 145TC, 182C, 184C	.7/8"
(Q)DRK-182TC	182TC, 184TC, 213C, 254C	1-1/8"
(Q)DRK-213TC	213TC, 215TC, 254UC, 256UC	1-3/8"
(Q)DRK-254TC	254TC, 256TC	1-5/8"

Quadrature Output (QDRK Series)

Provides two square wave output pulses offset from each other by 90°. The pulses lead or lag each other depending on the direction of shaft rotation.

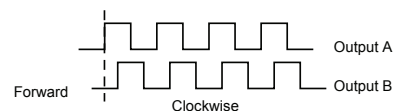

Quadrature Sensor Adjustment (QDRK Series)

All ring kits are preset at the factory to a 0.020" gap distance and aligned for a 90° phase shift. To adjust gap distance between the magnet ring and the sensor, use these steps (see figure 1):

1. With the mounting ring and magnet wheel mounted, set the gap adjustment screw so that it extends approximately 1/8" below the adjustment block.
2. Place the sensor with the guide post fitting into the guide hole and the barrel of the sensor down the neck of the ring. The sensor face should be resting on the magnet wheel.
3. Apply a slight downward pressure on the sensor and turn the gap adjustment screw clockwise until it rests on the base of the junction box.
4. With continued pressure on the sensor, adjust the gap adjustment screw 3/4 turn clockwise, raising the face of the sensor slightly off the magnet ring, and tighten the set screws on the neck of the ring kit. This procedure will result in the sensor being gapped to approximately 0.020". The kit is now ready to run.

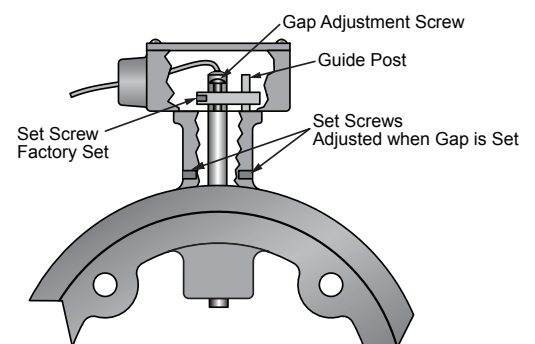
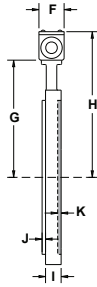
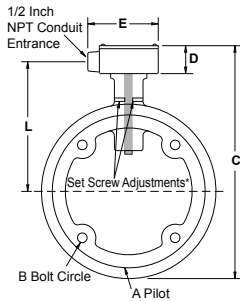
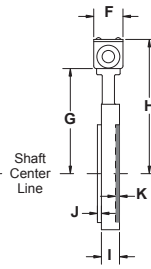
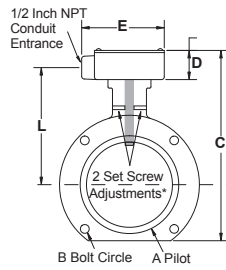

Figure 1

Large NEMA C Ring Kit



Small NEMA C Ring Kit



199SM Magnet Wheel

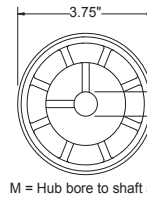
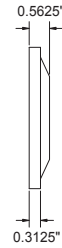

Sensors #1101RK and #1102RK

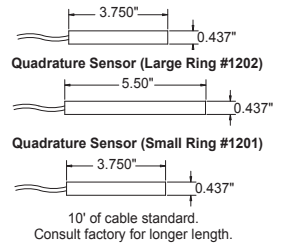

* Two set screws needed to secure sensor. It is critical that the magnet wheel is centered directly under the sensing head in the neck of the aluminum ring.

Kit	A	B	C	D	E	F	G	H	I	J	K	L	M
(Q)DRK-56C	4.50"	5.875"	9.04"	1.52"	3.85"	1.39"	4.86"	6.38"	0.78"	0.12"	0.16"	5.485"	5/8"
(Q)DRK-143TC	4.50"	5.875"	9.04"	1.52"	3.85"	1.39"	4.86"	6.38"	0.78"	0.12"	0.16"	5.485"	7/8"
(Q)DRK-182TC	8.50"	7.25"	12.81"	1.52"	3.85"	1.39"	6.47"	8.00"	0.86"	0.19"	0.21"	7.095"	1-1/8"
(Q)DRK-213TC	8.50"	7.25"	12.81"	1.52"	3.85"	1.39"	6.47"	8.00"	0.86"	0.19"	0.21"	7.095"	1-3/8"
(Q)DRK-254TC	8.50"	7.25"	12.81"	1.52"	3.85"	1.39"	6.47"	8.00"	0.86"	0.19"	0.21"	7.095"	1-5/8"

Specifications

Model #1101RK Sensor, 60 PPR Hall Effect	
Supply Voltage	5-24 VDC @ 10 mA
Model #1102RK Sensor, 120 PPR Magnetoresistive	
Supply Voltage	5-24 VDC @ 10 mA
Models #1101RK and #1102RK Sensors	
Output Type	NPN open collector
Operating Frequency	0-20 KHz
Sensing Distance	0.020" factory preset, 0.040" maximum
Material	304 Stainless steel
Operating Temperature	-40 °C to +60 °C * (-40 °F to +140 °F)
Cable	3-conductor shielded, 10' supplied
Color Code	Red = Supply (+) Clear = Signal output Black = Ground Shield = Tie to signal ground
NEMA Rating	4

Models #1201 and #1202 Quadrature Sensors, 60 PPR	
Supply Voltage	5-24 VDC @ 20 mA
Output Type	NPN open collector sink 20 mA/channel
Signal	Quadrature, ±15° from 90° phase shift
Operating Frequency	0-20 KHz
Sensing Distance	0.020" factory preset, 0.040" maximum
Material	304 Stainless steel
Operating Temperature	-40 °C to +60 °C * (-40 °F to +140 °F)
Cable	4-conductor shielded, 10' supplied
Color Code	Red = Supply (+) White = Signal output channel A Green = Signal output channel B Black = Signal ground Shield = Tie to signal ground

* Consult factory for higher temperature ranges
Specifications subject to change without notice.

199SM Magnet Wheel	
Magnetic Ring Material	Ferrous nylon
Number of Magnets	120 alternating North and South poles
Hub Material	Aluminum casting
Attachment Method	2 set screws, 90° apart
Max. Operating Speed	10,000 rpm
Bore Sizes	5/8", 7/8", 1-1/8", 1-3/8", 1-5/8" (std) Special bores up to 3" maximum are available
Operating Temperature	-20 °C to +60 °C * (-4 °F to +140 °F)

Mounting Ring and Junction Box	
Material	Aluminum casting
Conduit Entrance	1/2 inch NPT

Customization

If one of standard products does not meet your specifications, please do not hesitate to call one of our applications specialists. Many of our products can be customized to fit specific needs.

Additional Information

For more information about Digital Ring Kits, please contact Electro-Sensors.

See page 3 for ordering information.



Reliable Products
Trustworthy People

Digital Ring Kit

Shaft Speed Pulse Generators

Ordering

DRK

Digital Ring Kit Model	Part Number
Small Ring Kit: NEMA 56C, 5/8" bore	
DRK56C Ring Kit, 1101RK, 199SM, 0.625	775-210625
DRK56C Ring Kit, 1102RK, 199SM, 0.625	775-230625
Small Ring Kit: NEMA 143TC, 145TC, 182C, 184C, 7/8" bore	
DRK143TC Ring Kit, 1101RK, 199SM, 0.875	775-210875
DRK143TC Ring Kit, 1102RK, 199SM, 0.875	775-230875
Large Ring Kit: NEMA 182TC, 184TC, 213C, 215C, 254C, 1-1/8" bore	
DRK182TC Ring Kit, 1101RK, 199SM, 1.125	775-221125
DRK182TC Ring Kit, 1102RK, 199SM, 1.125	775-241125
Large Ring Kit: NEMA 213TC, 215TC, 254UC, 256UC, 1-3/8" bore	
DRK213TC Ring Kit, 1101RK, 199SM, 1.375	775-221375
DRK213TC Ring Kit, 1102RK, 199SM, 1.375	775-241375
Large Ring Kit: NEMA 254TC, 256TC, 1-5/8" bore	
DRK254TC Ring Kit, 1101RK, 199SM, 1.625	775-221625
DRK254TC Ring Kit, 1102RK, 199SM, 1.625	775-241625

QDRK

Quadrature Digital Ring Kit Model	Part Number
Small Quadrature Ring Kit: NEMA 56C, 5/8" bore	
QDRK56C Ring Kit, 1201, 199SM, 0.625	775-250625
QDRKL-56C Quad Ring Kit Line Driver	775-280625
Small Quadrature Ring Kit: NEMA 143TC, 145TC, 182C, 184C, 7/8" bore	
QDRK143TC Quad Ring 1201, 199SM, 0.875	775-250875
QDRKL143TC Quad Ring Kit Line Driver	775-280875
Large Quadrature Ring Kit: NEMA 182TC, 184TC, 213C, 215C, 254C, 1-1/8" bore	
QDRK182TC Quad Ring 1202, 199SM, 1.125	775-261125
Large Quadrature Ring Kit: NEMA 213TC, 215TC, 254UC, 256UC, 1-3/8" bore	
QDRK213TC Quad Ring 1202, 199SM, 1.375	775-261375
Large Quadrature Ring Kit: NEMA 254TC, 256TC, 1-5/8" bore	
QDRK254TC Quad Ring 1202, 199SM, 1.625	775-261625

Spare Parts

Option	Part Number
1101RK SS 3.75" HE 10' PVC w/o LBKT	775-110003
1102RK SS 3.75" MR 10' PVC w/o LBKT	775-110006
1201 SS 3.75" BIDI, 10' PVC, w/RK Block (Small quadrature sensor)	775-120101
1202 SS 5.5" BIDI 10' PVC, w/RK Block (Large quadrature sensor)	775-120201

