

---

# User manual

---

magnetic absolute  
positioning drive with **CANopen** interface

## AG03/1

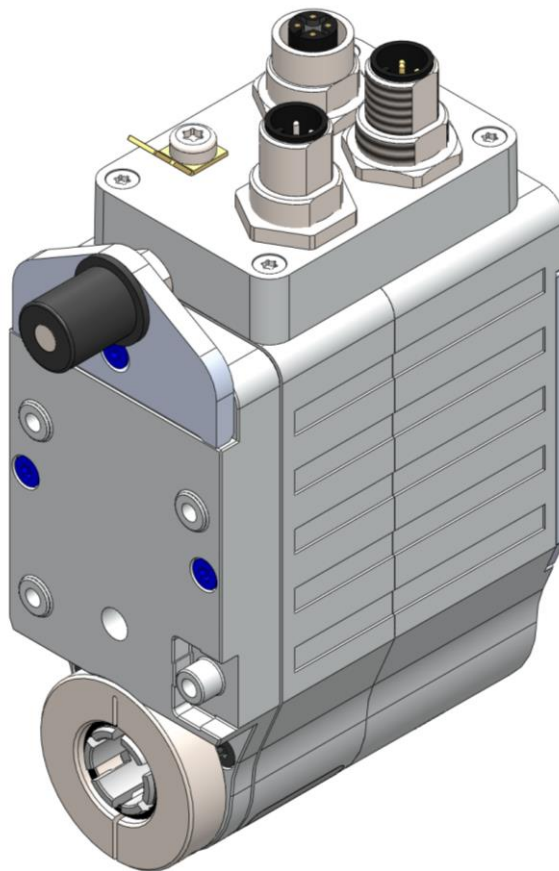



<b>1</b>	<b>GENERAL REMARKS</b> .....	<b>5</b>
1.1	DOCUMENTATION .....	5
1.2	BLOCK DIAGRAM .....	5
<b>2</b>	<b>FUNCTIONAL DESCRIPTION</b> .....	<b>6</b>
2.1	SYSTEM STATUS WORD.....	6
2.2	OPERATING MODES .....	7
2.2.1	<i>Positioning mode</i> .....	7
2.2.1.1	Loop positioning .....	8
2.2.1.2	Inching operation .....	9
2.2.2	<i>Velocity mode</i> .....	11
2.3	TORQUE DEACTIVATION .....	11
2.4	RESTORE FACTORY SETTINGS VIA DIP SWITCHES .....	12
2.5	DRIVE BEHAVIOR IN CASE OF POWER FAILURE .....	12
<b>3</b>	<b>CALIBRATION</b> .....	<b>13</b>
<b>4</b>	<b>EXTERNAL GEAR UNIT</b> .....	<b>13</b>
<b>5</b>	<b>WARNINGS / FAULTS</b> .....	<b>14</b>
5.1	WARNINGS.....	14
5.2	FAULTS.....	14
5.2.1	<i>Error codes</i> .....	14
<b>6</b>	<b>PARAMETER DESCRIPTION</b> .....	<b>15</b>
<b>7</b>	<b>COMMUNICATION VIA CAN BUS</b> .....	<b>19</b>
7.1	GENERAL REMARKS.....	19
7.1.1	<i>Interface</i> .....	19
7.2	CANOPEN PROTOCOL .....	19
7.2.1	<i>Telegram setup</i> .....	19
7.2.2	<i>Network management (NMT)</i> .....	20
7.2.2.1	State Diagramm.....	20
7.2.2.2	NMT Status 'INITIALISATION' .....	20
7.2.2.3	NMT Status 'PRE-OPERATIONAL' .....	21
7.2.2.4	NMT Status 'OPERATIONAL' .....	21
7.2.2.5	NMT Status 'STOPPED' .....	21
7.2.2.6	Switching between communication states.....	21
7.2.3	<i>SYNC object</i> .....	22
7.2.4	<i>Process Data Objects (PDOs)</i> .....	22
7.2.5	<i>Transmit PDOs</i> .....	22
7.2.5.1	1 <sup>st</sup> Transmit PDO (TPDO1).....	22
7.2.5.2	3 <sup>rd</sup> Transmit PDO (TPDO3) .....	23
7.2.5.3	4 <sup>th</sup> Transmit PDO (TPDO4) .....	23
7.2.5.4	Transfer types of the Transmit PDOs .....	23
7.2.6	<i>Receive PDOs</i> .....	24
7.2.6.1	1 <sup>st</sup> Receive PDO (RPDO1) .....	24
7.2.6.2	3 <sup>rd</sup> Receive PDO (RPDO3).....	24
7.2.6.3	4 <sup>th</sup> Receive PDO (RPDO4) .....	25
7.2.6.4	Transfer types of the Receive PDOs .....	25
7.2.7	<i>Service Data Objects (SDOs)</i> .....	26
7.2.7.1	Error code .....	27
7.2.8	<i>Example: Parameterization</i> .....	27
7.2.8.1	Example: Read parameter.....	27
7.2.8.2	Example: Write parameter.....	28
7.2.9	<i>Emergency Object (EMCY)</i> .....	29
7.2.9.1	Error Code .....	29
7.2.10	<i>Heartbeat protocol</i> .....	30



7.2.11	Node Guarding.....	31
7.3	STATE MACHINE.....	32
7.4	STATUS WORD .....	34
7.5	CONTROL WORD.....	36
7.6	FLOWCHART OF THE PROFILE POSITION MODE (POSITIONING MODE) .....	38
7.7	FLOWCHART OF THE PROFILE VELOCITY MODE OPERATION MODE (VELOCITY MODE) .....	39
7.8	EXAMPLES .....	40
7.8.1	Example of the Profile Position Mode (positioning mode).....	40
7.8.2	Example of the Profile Velocity Mode (velocity mode) .....	40
7.9	OVERVIEW OF CANOPEN IDENTIFIERS.....	41
7.10	SETTING THE CAN BAUD RATE .....	41
7.11	EDS FILE .....	41
7.12	DIRECTORY OF OBJECTS.....	41
7.12.1	Overview of objects .....	42
7.12.2	Description of objects .....	43
7.12.2.1	1000 <sub>h</sub> : Device Type .....	44
7.12.2.2	1001 <sub>h</sub> : Error Register.....	44
7.12.2.3	1002 <sub>h</sub> : Manufacturer Status Register .....	45
7.12.2.4	1003 <sub>h</sub> : Pre-defined Error Field.....	45
7.12.2.5	1005 <sub>h</sub> : COB-ID Sync Message .....	46
7.12.2.6	1008 <sub>h</sub> : Manufacturer Device Name .....	46
7.12.2.7	100A <sub>h</sub> : Manufacturer Software Version .....	47
7.12.2.8	100C <sub>h</sub> : Guard Time.....	47
7.12.2.9	100D <sub>h</sub> : Life Time Factor.....	47
7.12.2.10	1011 <sub>h</sub> : Restore Default Parameters.....	48
7.12.2.11	1014 <sub>h</sub> : COB-ID Emergency Message.....	49
7.12.2.12	1017 <sub>h</sub> : Producer Heartbeat Time.....	49
7.12.2.13	1018 <sub>h</sub> : Identity Objekt .....	50
7.12.2.14	1200 <sub>h</sub> : Server SDO Parameter .....	51
7.12.2.15	1400 <sub>h</sub> : 1 <sup>st</sup> Receive PDO Parameter .....	52
7.12.2.16	1401 <sub>h</sub> : 2 <sup>nd</sup> Receive PDO Parameter .....	53
7.12.2.17	1402 <sub>h</sub> : 3 <sup>rd</sup> Receive PDO Parameter.....	54
7.12.2.18	1403 <sub>h</sub> : 4 <sup>th</sup> Receive PDO Parameter .....	55
7.12.2.19	1600 <sub>h</sub> : 1 <sup>st</sup> Receive PDO Mapping Parameter .....	57
7.12.2.20	1601 <sub>h</sub> : 2 <sup>nd</sup> Receive PDO Mapping Parameter .....	57
7.12.2.21	1602 <sub>h</sub> : 3 <sup>rd</sup> Receive PDO Mapping Parameter .....	58
7.12.2.22	1603 <sub>h</sub> : 4 <sup>th</sup> Receive PDO Mapping Parameter .....	59
7.12.2.23	1800 <sub>h</sub> : 1 <sup>st</sup> Transmit PDO Parameter .....	60
7.12.2.24	1801 <sub>h</sub> : 2 <sup>nd</sup> Transmit PDO Parameter .....	61
7.12.2.25	1802 <sub>h</sub> : 3 <sup>rd</sup> Transmit PDO Parameter.....	62
7.12.2.26	1803 <sub>h</sub> : 4 <sup>th</sup> Transmit PDO Parameter.....	64
7.12.2.27	1A00 <sub>h</sub> : 1 <sup>st</sup> Transmit PDO Mapping Parameter.....	66
7.12.2.28	1A01 <sub>h</sub> : 2 <sup>nd</sup> Transmit PDO Mapping Parameter.....	66
7.12.2.29	1A02 <sub>h</sub> : 3 <sup>rd</sup> Transmit PDO Mapping Parameter.....	67
7.12.2.30	1A03 <sub>h</sub> : 4 <sup>th</sup> Transmit PDO Mapping Parameter.....	67
7.12.2.31	2100 <sub>h</sub> : CAN baud rate.....	68
7.12.2.32	2101 <sub>h</sub> : Node-ID .....	69
7.12.2.33	2102 <sub>h</sub> : Gear reduction.....	69
7.12.2.34	2410 <sub>h</sub> : Motor Parameter Set.....	70
7.12.2.35	2412 <sub>h</sub> : Spindle Pitch .....	72
7.12.2.36	2413 <sub>h</sub> : Pos Type .....	72
7.12.2.37	2415 <sub>h</sub> : Delta Jog .....	72
7.12.2.38	2416 <sub>h</sub> : Stop Mode Inching Mode 2 .....	73
7.12.2.39	2417 <sub>h</sub> : Inpos Mode.....	73
7.12.2.40	2418 <sub>h</sub> : Loop Length .....	73
7.12.2.41	241B <sub>h</sub> : Power Supply Voltage .....	73
7.12.2.42	241C <sub>h</sub> : Output Stage Temperature.....	74
7.12.2.43	241E <sub>h</sub> : Motor Current.....	74
7.12.2.44	2420 <sub>h</sub> : Generic Status Register .....	74
7.12.2.45	2421 <sub>h</sub> : Torque Deactivation .....	75



7.12.2.46	2422 <sub>h</sub> : Torque Deactivation State.....	75
7.12.2.47	2423 <sub>h</sub> : Battery Voltage.....	75
7.12.2.48	2450 <sub>h</sub> : Inching 2 Offset.....	76
7.12.2.49	2500 <sub>h</sub> : Production Date.....	76
7.12.2.50	6040 <sub>h</sub> : Control word.....	76
7.12.2.51	6041 <sub>h</sub> : Status word.....	77
7.12.2.52	6060 <sub>h</sub> : Modes of Operation.....	77
7.12.2.53	6064 <sub>h</sub> : Position Actual Value.....	77
7.12.2.54	6067 <sub>h</sub> : Position Window.....	78
7.12.2.55	606C <sub>h</sub> : Velocity Actual Value.....	78
7.12.2.56	607A <sub>h</sub> : Target Position.....	78
7.12.2.57	607C <sub>h</sub> : Calibration Value.....	79
7.12.2.58	607D <sub>h</sub> : Software Position Limit.....	79
7.12.2.59	607E <sub>h</sub> : Polarity.....	80
7.12.2.60	6091 <sub>h</sub> : Gear Ratio.....	80
7.12.2.61	60FF <sub>h</sub> : Target Velocity.....	81
7.13	SETTING THE NODE ADDRESS OF THE AG03/1.....	81
7.14	DIAGNOSIS LEADS.....	82
7.15	CAN BUS TERMINATION.....	82

# 1 General remarks

This user manual is valid with firmware version 4.01 or higher!

## 1.1 Documentation

The following documents are associated with this document:

- The Product data sheet describes the technical data, the dimensions, the pin assignment, the accessories and the order key.
- The installation instructions describe the mechanical and electrical installation with all safety-relevant conditions and the associated technical specifications.
- The User manual for actuator commissioning and integration into a fieldbus system.

You can also download these documents at <http://www.siko.de/en/service/downloads/selected-downloads/details/aq031/>.

## 1.2 Block Diagram

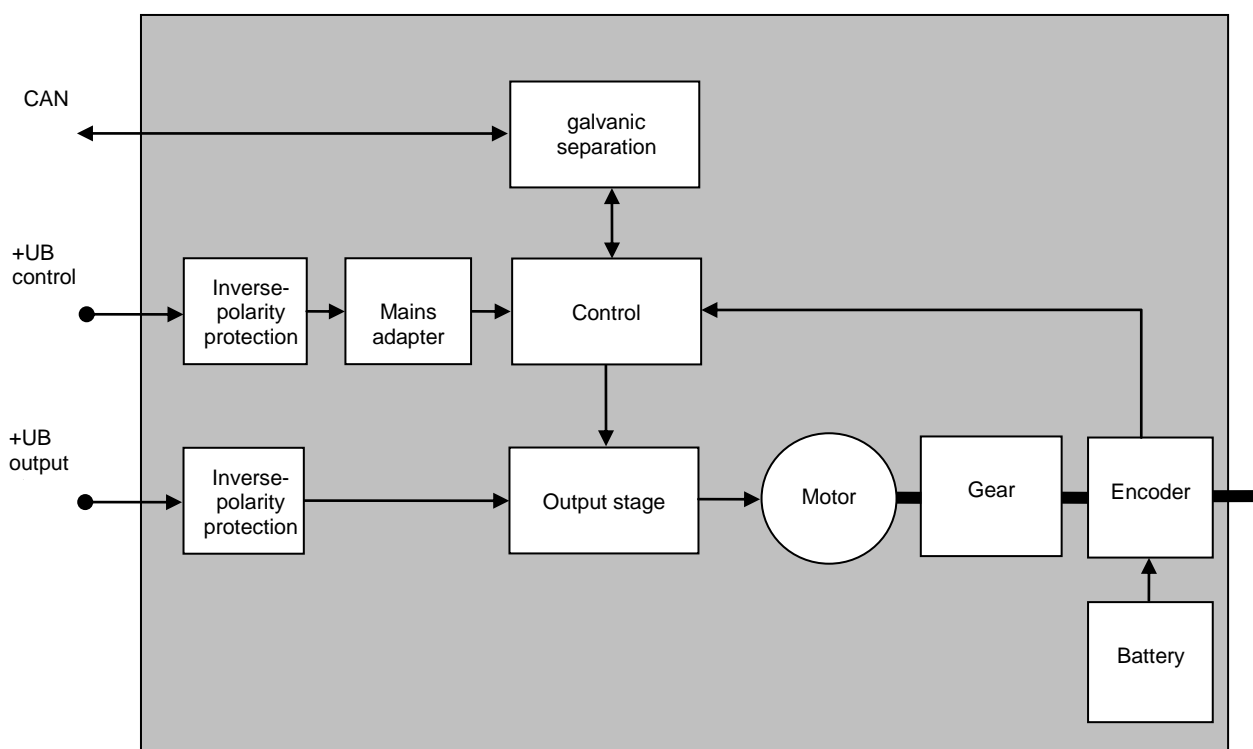

## 2 Functional description

This chapter describes the operating cycles, functions and states required for the operation of the positioning drive.

Communication via CANopen is taken as the basis for the information presented in this chapter.

### 2.1 System status word

The system status word of the AG03/1 consists of 2 bytes and reflects the state of the AG03/1. The system status word can be read via Object 1002<sub>h</sub> (Manufacturer Status Register).

High- Byte								Low- Byte							
Bit – number															
15	14	13	12	11	10	9	8	7	6	5	4	3	2	1	0
0	0	1	0	1	0	0	1	0	1	0	0	1	0	0	0
2				9				4				8			

Fig. 1: System status word format

Example (grey background):

binary: ⇒ 0010 1001 0100 1000

hex: ⇒ 2 9 4 8

The table below informs about the meaning of the individual bits of the status word:

Bit	State	Description
Bit 0	'0'	no meaning
Bit 1	'0'	no meaning
Bit 2	'0'	no meaning
Bit 3	'1'	<b>Positioning mode: In position</b> Actual position is within the positioning window of the programmed target value.
	'0'	Actual position is beyond the positioning window of the programmed target value.
	'1'	<b>Velocity mode: In position</b> Actual velocity is within the specified tolerance window of the target speed
	'0'	Actual speed is outside the specified tolerance window.
Bit 4	'1'	<b>Drive travels:</b> Drive travels
	'0'	Drive stands still (velocity < 2 rev./min)
Bit 5	'1'	<b>Positioning mode: upper limit:</b> Actual position is above the higher programmed limit of limits 1+2. Travelling is possible only in negative direction in inching operation.
	'0'	Actual position is below the programmed limit.
	'0'	<b>Velocity mode:</b> no meaning
Bit 6	'1'	<b>Positioning mode: lower limit:</b> Actual position is below the lower programmed limit of limits 1+2. Travelling is possible only in positive direction in inching operation.
	'0'	Actual position is above the programmed limit.
	'0'	<b>Velocity mode:</b> no meaning

Bit	State	Description
Bit 7	'1'	<b>Driver state:</b> Motor is enabled
	'0'	Motor in control
Bit 8	'1'	<b>Fault:</b> The AG03/1 has switched to fault. The cause of the fault must be cleared and acknowledged via 'CW.7=1' command. For the fault cause see chapter 5.2
	'0'	No fault present
Bit 9	'1'	<b>Positioning mode: loop travel:</b> If travel direction unequal start direction (with loop travel)
	'0'	If travel direction equal start direction
	'0'	<b>Velocity mode:</b> no meaning
Bit 10	'1'	<b>Supply voltage of the output stage</b> Supply voltage of the output stage is not applied Gear travel is disabled!
	'0'	Supply voltage of the output stage is applied
Bit 11	'1'	<b>Ready-to-travel:</b> Not ready-to-travel
	'0'	Ready-to-travel: <ul style="list-style-type: none"> <li>• AG03/1 not in fault state</li> <li>• No active positioning</li> <li>• Supply voltage of the output stage is applied</li> <li>• actual position within limits (only positioning mode)</li> </ul>
Bit 12	'1'	<b>Battery voltage:</b> Battery voltage too low for absolute encoder. Replace the battery within half a year after notification by the error bit!
	'0'	Battery voltage OK.
Bit 13	'1'	<b>Motor current:</b> Motor current beyond permissible range. If this state lasts for more than 4 s, the AG03/1 switches to fault.
	'0'	Motor current within permissible range.
Bit 14	'1'	<b>Positioning mode: status</b> Positioning active in positioning mode.
	'0'	Positioning inactive.
	'0'	<b>Velocity mode:</b> no meaning
Bit 15	'1'	<b>Lag error:</b> Lag error ⇒ AG03/1 cannot reach the preset speed due to too high load. This state should be avoided! Remedy: reduce programmed speed!
	'0'	No lag error ⇒ actual speed corresponds with required speed.

Table 1: System status word

## 2.2 Operating modes

The following operating modes are available: positioning mode and velocity mode.  
In the positioning mode there is the additional option of travelling with inching operation.

### 2.2.1 Positioning mode

Parameter no 20 'Operating mode' is programmed to positioning mode (see chapter 6: Parameter description)

In the positioning mode, positioning to the target value is effected by means of a ramp function (see fig. 2), which is calculated on the basis of the actual position as well as the programmed controller parameters P (proportional factor), I (integral factor), D (differential factor), acceleration and speed (see chapter 6: Parameter description).

After activation of the travel order (see chapter 7.6 Flowchart: Positioning mode) the AG03/1 accelerates with the pre-programmed acceleration to the specified speed. The measure of deceleration to reach the target value is also defined by the parameter 'a-pos'. Alternatively, a value deviating from acceleration can be chosen for delay (see chapter 6: Parameter No. 31 'd-Pos').

If the actual position is within the programmed window (see chapter 6: Parameter No. 10), this will be signalled in the system status word (bit 3). The drive's behaviour upon reaching the pre-programmed window can be defined (see chapter 6: Parameter No. 26).

Changing controller parameters during a positioning process does not influence the current positioning operation.

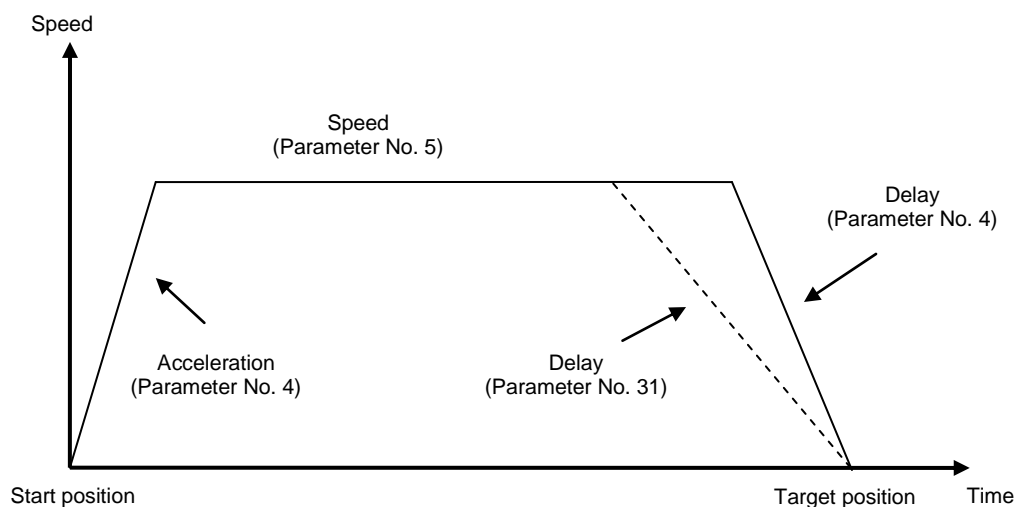

Fig. 2: Ramp travel in positioning mode (direct)

Travel orders can only be started if the following conditions have been met:

- the AG03/1 must not be switched to fault (*system status word bit 8 = '0'*)
- actual position is within the programmed limiting values. (*system status word bits 5 + 6 = '0'*)
- no active travel job present (*system status word bit 14 = 0*)
- Supply voltage of the output stage is applied (*system status word bit 10 = '0'*)

ZSW.15 = '1' is signalled when these conditions have been met.

### 2.2.1.1 Loop positioning

If the AG03/1 is operated on a spindle or an additional drive, the spindle or external drive play can be compensated by means of loop positioning.

In this case, travelling to the target value is always from the same direction.

This travel direction can be defined via the parameter no. 19 'Pos- Art' (see chapter 6: Parameter description).



Example:

Assumption: The direction of travelling for reaching any target position is positive (see chapter 6: Parameter no. 19 'Pos Art' = loop)

- Case 1  $\Rightarrow$  new position is greater than actual position:

Direct travel to target position.

- Case 2  $\Rightarrow$  new position is smaller than actual position:

The AG03/1 travels beyond the target position by the loop length (parameter no. 27) (bit 9 in the system status word signals travel direction unequal start direction); afterwards, travelling to the target value is in positive direction.

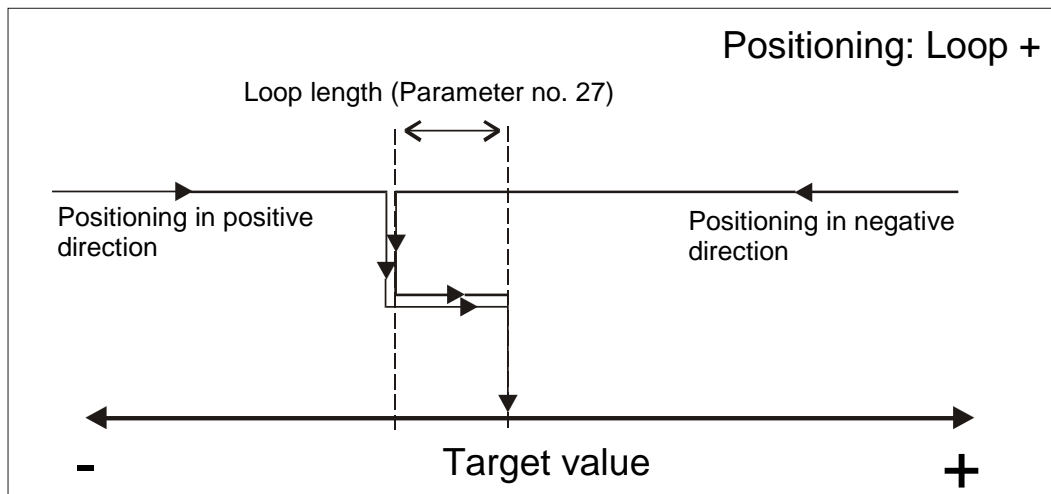

Fig. 3: Loop+ positioning

### 2.2.1.2 Inching operation

Inching operation is enabled in the 'Positioning mode' only. Acceleration and speed in the inching operation can be programmed via parameter no. 8 'a- Inch' and parameter no. 9 'v- Inch'.

<b>NOTICE</b>	There is no compensation for spindle play (loop positioning) in this travel type!
---------------	---

There are three options for travelling with inching operation:

- **Inching operation 1**

Inching operation 1 is started via CW.13 = '1' in the control word.

The drive travels once from the current position by the position 'Delta Inch'.

The travel direction is positive or negative depending on the arithmetical sign (parameter no. 17 'Delta- Inch').

- Parameter 'Delta Inch' < 0: negative travel direction
- Parameter 'Delta Inch' > 0: positive travel direction

If the parameter no. 13 'Spindle pitch' is programmed to zero, then there is an incremental travelling way. If the 'spindle pitch' is unequal zero, then the information of the 'Delta Inch' parameter refers to the travel distance in 1/100 mm.  
Reaching the target position will be signalled in the system status word (bit 3).

- **Inching operation 2**

Inching operation is started via CW.14 = '1' (positive travel direction) or CW.15 = '1' (negative travel direction), respectively.

The drive moves at the pre-programmed speed as long as this bit = '1'.

- **Manual setup mode**

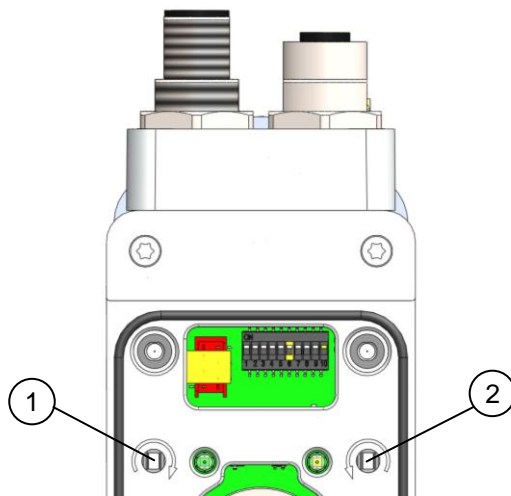

The manual setup mode (corresponding to inching operation 2) can be started by means of the operator keys enabling traveling of the actuator without a superordinate control

Key (1) clockwise movement  
Key (2) counter-clockwise movement

<b>NOTICE</b>	The manual setup mode is not available in the NMT – "OPERATIONAL" und "STOPPED" states.
---------------	---

The following conditions must be met to enable the start of inching operation 1 and 2 or manual setup operation, respectively:

- The AG03/1 must not be switched to fault (*system status word bit 8 = '0'*)
- No active travel job present (*system status word bit 14 = '0'*)
- Supply voltage of the output stage is applied (*system status word bit 10 = '0'*)

<b>NOTICE</b>	If the actual position is outside the programmed limits, traveling in the relevant direction is possible by means of inching operation 1 or 2 or manual setup!
---------------	--

## 2.2.2 Velocity mode

Parameter no 20 'operating mode' is programmed to velocity mode (see chapter 6: *Parameter description*).

In the velocity mode, the AG03/1 accelerates to the target velocity after release of the setpoint value (see chapter 7.7 *Flowchart: velocity mode*) and maintains this velocity until the setpoint value is disabled or a new target velocity specified.

The speed is adjusted immediately to the new value when the rotational target speed is changed.

The arithmetical sign of the target value determines the travel direction in the velocity mode (see chapter 6: *Parameter description*).

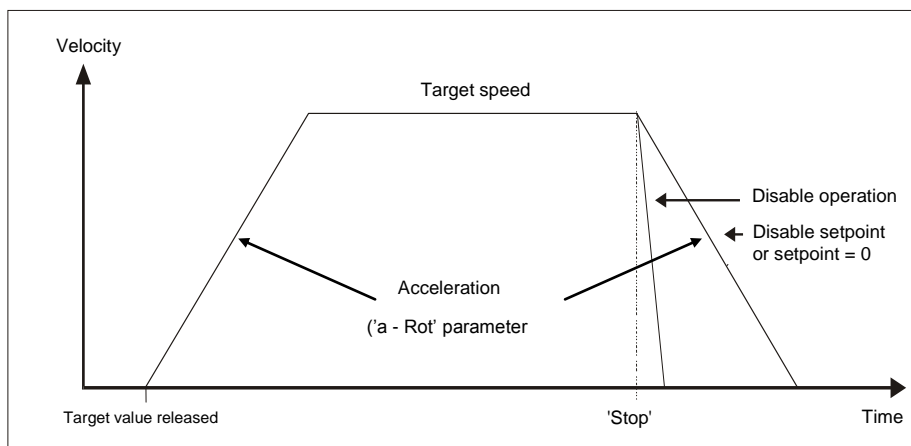

Fig. 5: Ramp velocity mode

The following conditions must be met for enabling start of velocity mode via the 'M' command of the standard protocol:

- The AG03/1 must not be switched to fault (*system status word bit 8 = '0'*)
- no active travel job present (*system status word bit 14 = '0'*)
- Supply voltage of the output stage is applied (*system status word bit 10 = '0'*)

If these conditions are met, this will be signalled in the system status word by bit 11 = '0'.

<b>NOTICE</b>	Limits 1 + 2 are deactivated in this operational mode!
---------------	--

## 2.3 Torque deactivation

A deactivation threshold is defined via the torque deactivation parameter (see chapter 5: *Parameter description* ⇒ *Parameter No. 29*). Percent values are entered.

Torque deactivation is disabled with a parameter value of 125 %.

The drive will decelerate with maximum delay when the deactivation threshold is exceeded. Drive control will be maintained.

<b>NOTICE</b>	Active torque deactivation causes no error!
---------------	---

Active deactivation is signaled in Object 2422<sub>h</sub> (Torque Deactivation State) Bit 0 = '1'. This bit will be automatically reset when the current travel order is resumed. Alternately, the status of torque deactivation is mapped in Object 2420<sub>h</sub> (Generic State Register).

<b>NOTICE</b>	This function is only available in the positioning mode!
---------------	--

## 2.4 Restore factory settings via DIP switches

Procedure for restoring factory settings via the 10-pin DIP switch:

1. Switch off supply voltage.
2. Set DIP switches 1 – 8 depending on the parameters to be reset:

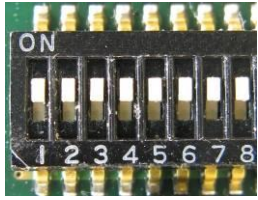
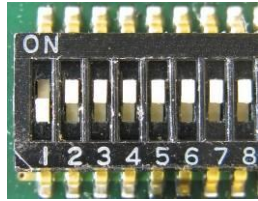
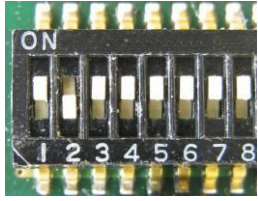
Reset all parameters (see chapter 6: <i>Parameter description</i> ) to factory settings	
Reset only standard parameters (see chapter 6: <i>Parameter description</i> ) to factory settings	
Reset only controller parameters (see chapter 6: <i>Parameter description</i> ) to factory settings	

3. Turn on supply voltage. AG03/1 acknowledges with alternating blinking of the status LED and the bus LED.
4. Switch off supply voltage.
5. Set the original bus address via DIP switches 1 - 7.
6. DIP switch number 8 must be set to the OFF position.
7. After next switching on of supply voltage, the previously selected parameters will have been reset to the factory settings.

## 2.5 Drive behavior in case of power failure

<b>NOTICE</b>	Power failure results in immediate loss torque. If the drive is moving at the time of power failure, then the drive will run out non-braked!
---------------	--

### 3 Calibration

Since the measuring system is an absolute system, calibration is necessary only once at start-up. During calibration, the position value of the AG03/1 is set to the programmed calibration value (see chapter 6: *Parameter description*  $\Rightarrow$  parameter no. 14).

The measuring system is calibrated via Object 1011<sub>h</sub> (Restore Default Parameters).

<b>NOTICE</b>	Calibration is only possible when no travel job is active!
---------------	--

### 4 External gear unit

If an external gear unit is used, a factor can be programmed via the parameter no. 11 'ü - Numerator' (numerator) and parameter no. 12 'ü - Denominator' (denominator), in order to include the gear ratio in position sensing (see also chapter 2.2.1.1).

Example (see fig. 7):

The AG03/1 is operated on a gear with transfer reduction of 5:1. For this purpose, the parameters 'ü-Numerator' and 'ü-Denominator' must be programmed as follows:

- Parameter 'ü - Numerator' : 5
- Parameter 'ü - Denominator' : 1

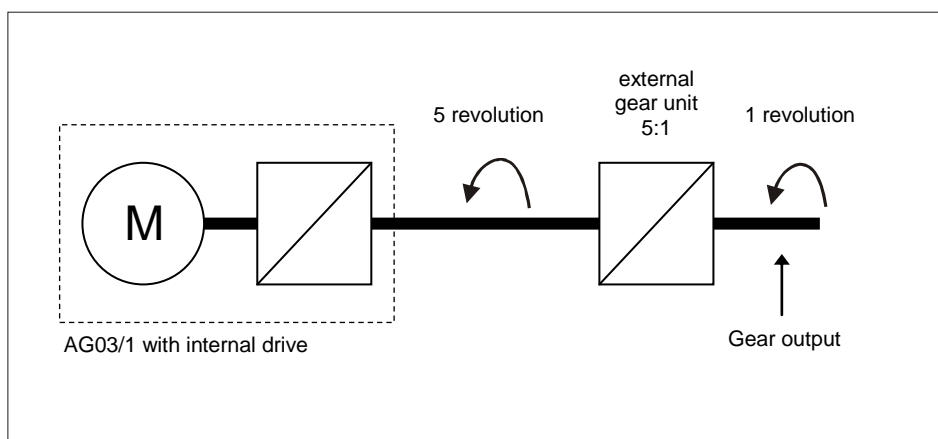

Fig. 7: External gear unit

Input of an odd gear reduction value is possible according to the following example:

Transfer reduction = 3.78

- Parameter 'ü - Numerator': 378
- Parameter 'ü - Denominator': 100

## 5 Warnings / Faults

The AG03/1 distinguishes between warnings and faults:

### 5.1 Warnings

Warnings do not influence the operation of the positioning drive. Warnings disappear after removing their causes.

Possible warnings:

- Battery voltage for absolute encoder is below limit  $\Rightarrow$  exchange battery within the next 6 months (see chapter 2.1: System status word  $\Rightarrow$  bit 12).
- Motor current beyond the permissible range (see chapter 2.1: System status word  $\Rightarrow$  bit 13)  
 $\Rightarrow$  if this condition lasts longer than 4 s, the AG03/1 will switch to fault.
- Lag error present (see chapter 2.1: System status word  $\Rightarrow$  bit 15)  $\Rightarrow$  AG03/1 cannot reach programmed speed because load is too high.

### 5.2 Faults

Faults induce an immediate stop of the positioning drive. The status-LED signalizes the fault status (see Installation instructions). Based on the blink code, the cause of the fault can be tracked down (see tab. 2: Error codes). Furthermore, a pending error can be detected via the status word (see CAN-Bus chapter 7.4: Status word).

The error messages are entered in the error buffer in the order of their detection. The last 10 fault messages are displayed when the fault buffer is full.

The cause of an error can be tracked down with the help of the error codes (see table 2: Error codes). The error buffer is stored in the EEPROM and can be deleted via Object "Pre-defined Error Field" (see CAN-Bus chapter 7.12.2 Object 1003<sub>h</sub>).

#### 5.2.1 Error codes

The following table lists possible error causes:

Value error buffer		Blink code green Status-LED	Error description
ASCII	HEX		
A	41h	blinking 1 time	supply voltage too low Error condition: Supply voltage < 18 V + motor current > 200 mA
B	42h	blinking 2 times	blocked drive shaft Error condition: Revolutions per minute < rpm + contouring error
C	43h	blinking 3 times	motor current too high Error condition: Motor current > 2,4 A more than 4 s
D	44h	blinking 4 times	output stage temperature too high Error condition: Output stage temperature > 90 °C
E	45h	blinking 5 times	SIN COS monitoring
F	46h	blinking 6 times	internal error

G	47h	blinking 7 times	intermediate circuit voltage too high Error condition: Intermediate circuit voltage > 35 V
H	48h	blinking 8 times	CAN-BUS error CAN-node switched to "ERROR PASSIVE" status during running positioning
I	49h	blinking 9 times	CAN-BUS error CAN-node switched to "BUS OFF" status.
J	4Ah	blinking 10 times	Battery voltage < 2,2 V Battery must be replaced

Table 2: Error codes

## 6 Parameter description

This chapter describes the parameters of the AG03/1.

All parameters are stored in the **non-volatile** EEPROM, except for parameter 24 (target value).

\* Controller parameters

\*\* Standard parameters

No.	Name	Selection / value	Default	Description
1	Controller parameter P *	1 – 500	100	<b>P gain of controller:</b> valid for all operating modes (positioning mode, velocity mode, inching operation) <i>CAN-Bus chapter 7.12.2: Object 2410<sub>h</sub> ⇒ sub-index 01<sub>h</sub></i>
2	Controller parameter I *	0 – 500	5	<b>I gain of controller:</b> valid for all operating modes (positioning mode, velocity mode, inching operation) <i>CAN-Bus chapter 7.12.2: Object 2410<sub>h</sub> ⇒ sub-index 02<sub>h</sub></i>
3	Controller parameter D *	0 – 500	0	<b>D gain of controller:</b> valid for all operating modes (positioning mode, velocity mode, inching operation) <i>CAN-Bus chapter 7.12.2: Object 2410<sub>h</sub> ⇒ sub-index 03<sub>h</sub></i>
4	a – Pos *	1 – 100	50	<b>Acceleration in positioning mode:</b> values in % (100 % ⇒ 4 U/s <sup>2</sup> ) <i>CAN-Bus chapter 7.12.2: Object 2410<sub>h</sub> ⇒ sub-index 04<sub>h</sub></i>
5	v – Pos *	1 – 100 1 – 200	30	<b>Maximum speed in positioning mode:</b> values in revolutions/min gear ratio 48:1 ⇒ max. 100 rev/min gear ratio 24:1 ⇒ max. 200 rev/min <i>CAN-Bus chapter 7.12.2: Object 2410<sub>h</sub> ⇒ sub-index 05<sub>h</sub></i>
6	a - Rot *	1 – 100	50	<b>Acceleration in velocity mode:</b> values in % (100 % ⇒ 4 U/s <sup>2</sup> ) <i>CAN-Bus chapter 7.12.2: Object 2410<sub>h</sub> ⇒ sub-index 06<sub>h</sub></i>
7				reserviert
8	a - Inch *	1 – 100	50	<b>Acceleration in inching operation 1 /2:</b> values in % (100 % ⇒ 4 U/s <sup>2</sup> ) <i>CAN-Bus chapter 7.12.2: Object 2410<sub>h</sub> ⇒ sub-index 08<sub>h</sub></i>
9	v - Inch *	1 – 100 1 – 200	30	<b>Maximum speed in inching operation 1 /2:</b> values in revolutions/min gear ratio 48:1 ⇒ max. 100 rev/min gear ratio 24:1 ⇒ max. 200 rev/min <i>CAN-Bus chapter 7.12.2: Object 2410<sub>h</sub> ⇒ sub-index 09<sub>h</sub></i>

No.	Name	Selection / value	Default	Description
10	Pos- Window **	0 - 1000	10	<p><b>Positioning mode: positioning window</b> If the actual position of the AG03/1 is within the programmed target value <math>\pm</math> this window, this is signalled by setting bit 3 in the system status word of the AG03/1 (see chapter 2.1) Spindle pitch = 0: Information refers to increments Spindle pitch <math>\neq</math> 0: Information refers to travelling distance in 1/100 mm</p> <p><b>Velocity mode: Velocity window</b> If the actual velocity is within the target velocity <math>\pm</math> this window, this is signalled by setting bit 3 in the system status word of the AG03/1 (see chapter 2.1). <i>CAN-Bus chapter 7.12.2: Object 6067<sub>h</sub></i></p>
11	ü – Numerator**	1 – 10000	1	<p><b>Numerator gear ratio:</b> a gear ratio can be programmed here when a gear unit is used (see chapter 4: External gear unit). <i>CAN-Bus chapter 7.12.2: Object 6091<sub>h</sub> <math>\Rightarrow</math> sub-index 01<sub>h</sub></i></p>
12	ü – Denominator **	1 – 10000	1	<p><b>Denominator gear ratio:</b> a gear ratio can be programmed here when a gear unit is used (see chapter 4: external gear unit). <i>CAN-Bus chapter 7.12.2: Object 2410<sub>h</sub> <math>\Rightarrow</math> sub-index 02<sub>h</sub></i></p>
13	Spindle pitch **	0 – 1000	0	<p><b>Spindle pitch:</b> Spindle pitch = 0: Position value is output in increments (1,600 increments per revolution of the driving shaft of the AG03/1). Spindle pitch parameter <math>\neq</math> 0: (when operating the AG03/1 on a spindle) Position value is no longer output as increments, but as travelling distance in 1/100 mm. Target position is entered now as 1/100 mm, too. Spindle pitch value in 1/100 mm. e. g. spindle with a pitch of 2 mm <math>\Rightarrow</math> spindle pitch parameter = 200. <i>CAN-Bus chapter 7.12.2: Object 2412<sub>h</sub></i></p>
14	Calibration value **	-999999 to 999999	0	<p><b>Calibration value:</b> Writing a value in this parameter results in the take-over of this value as the absolute position for the AG03/1. <b>Caution!</b> Value must be within the range of the preprogrammed limiting values. <i>CAN-Bus chapter 7.12.2: Object 607C<sub>h</sub></i></p>
15	Litmit 1 **	-9999999 to 9999999	1000000	<p><b>Positioning mode: Litmit 1</b> Spindle pitch = 0: Information refers to increments Spindle pitch = <math>\neq</math>0: Information refers to travelling distance in 1/100 mm If the AG03/1 is beyond the range defined by limit 1 and limit 2 (travel range), travelling will only be possible in the direction of the travel range in inching mode. <b>Achtung!</b> Limit monitoring is deactivated if 'limit 1' is equal 'limit 2'. Please note that there is a jump of the actual position if the resolution of the absolute encoder is exceeded!!! <b>Velocity mode:</b> no meaning <i>CAN-Bus chapter 7.12.2: Object 607D<sub>h</sub> <math>\Rightarrow</math> sub-index 02<sub>h</sub></i></p>



No.	Name	Selection / value	Default	Description
16	Litmit 2 **	-9999999 to 9999999	-1000000	<p><b>Positioning mode: Litmit 2</b>            Spindle pitch = 0: Information refers to increments            Spindle pitch = ≠0: Information refers to travelling distance in 1/100 mm            If the AG03/1 is beyond the range defined by limit 1 and limit 2 (travel range), travelling will only be possible in the direction of the travel range in inching mode.  <b>Achtung!</b> Limit monitoring is deactivated if 'limit 1' is equal 'limit 2'. Please note that there is a jump of the actual position if the resolution of the absolute encoder is exceeded!  <b>Velocity mode:</b> no meaning  <i>CAN-Bus chapter 7.12.2: Object 607D<sub>h</sub> ⇒ sub-index 01<sub>h</sub></i></p>
17	Delta Inch **	-1000000 to 1000000	1600	<p><b>Delta travelling distance with inching operation 1:</b>            indicates the relative travelling distance.            positive value ⇒ positive travelling direction            negative value ⇒ negative travelling direction            Spindle pitch = 0: Information refers to increments            Spindle pitch = ≠0: Information refers to travelling distance in 1/100 mm  <i>CAN-Bus chapter 7.12.2: Object 2415<sub>h</sub></i></p>
18	Sense of rotation **	i , e	i	<p><b>Counting direction of the measuring system:</b>            When the shaft rotates counter-clockwise (view on the clamping ring of the AG03/1).            i sense of rotation: ⇒ positive counting direction            e sense of rotation: ⇒ negative counting direction  <i>CAN-Bus chapter 7.12.2: Object 607E<sub>h</sub></i></p>
19	Pos Type **	direct loop + sloop -	direct	<p><b>Positioning mode: Type of positioning</b>  <i>direct:</i> direct travelling from actual position to target value  <i>loop +:</i> travelling to the target value occurs always in positive direction to compensate for spindle play  <i>loop -:</i> travelling to the target value occurs always in negative direction to compensate for spindle play.  <b>Caution!</b> Loop positioning in positioning mode only.  <b>Velocity mode:</b> no meaning  <i>CAN-Bus chapter 7.12.2: Object 2413<sub>h</sub></i></p>
20	Operating mode **	positioning mode / speed mode	positioning mode	<p><b>Positioning mode:</b>  <i>(see chapter 2.2.1: Positioning mode)</i>  <b>Velocity mode:</b>  <i>(see chapter 0: Velocity mode)</i>  <i>CAN-Bus chapter 7.12.2: Object 6060<sub>h</sub></i></p>
21				reserved
22				reserved
23				reserved

No.	Name	Selection / value	Default	Description
24	Setpoint **	see column 'Description'	0	<p><b>Positioning mode:</b> indicates absolute target position. Spindle pitch = 0: Information refers to increments Spindle pitch = <math>\neq 0</math>: Information refers to travelling distance in 1/100 mm Value range: depends on the pre-programmed target values (<i>parameters 15/16</i>)</p> <p><b>Velocity mode:</b> indicates the target velocity in rev./min. Value range: gear ratio 48:1 <math>\Rightarrow</math> max. <math>\pm 100</math> rev/min gear ratio 24:1 <math>\Rightarrow</math> max. <math>\pm 200</math> rev/min <i>CAN-Bus see chapter 7.2.5: Transmit PDO's</i> <b>Attention!</b> Target value will not be stored in the EEPROM</p>
25	Stop mode Inching mode 2 **	0/1	0	<p><b>Stop mode inching mode 2 / touch button mode</b> The stop behaviour of inching mode 2 or touch button operation can be parameterized in different ways. Stop mode = 0 stop with maximum delay Stop mode = 1 stop with pre-programmed delay (parameter no. 8) <i>CAN-Bus chapter 7.12.2: Object 2416<sub>h</sub></i></p>
26	Inpos mode **	0/1/2	0	<p><b>Operating mode: positioning mode:</b> The drive's behaviour upon reaching the positioning window can be determined by this parameter: Inpos mode = 0 position control to setpoint value Inpos mode = 1 position control OFF and short circuit of motor windings Inpos mode = 2 position control OFF and release of drive <b>Velocity mode:</b> no meaning <i>CAN-Bus chapter 7.12.2: Object 2417<sub>h</sub></i></p>
27	Loop length**	0 - 10000	800	<p><b>Operating mode: positioning mode:</b> Indicates the loop length in increments <b>Velocity mode:</b> no meaning <i>CAN-Bus chapter 7.12.2: Object 2418<sub>h</sub></i></p>
28				reserved
29	Torque deactivation **	20 - 125	125	<p><b>Operating mode: positioning mode:</b> This parameter determines the threshold of torque deactivation. Percent values are to be entered. Value 125: Torque deactivation disabled. <b>Velocity mode:</b> no meaning <i>CAN-Bus chapter 7.12.2: Object 2421<sub>h</sub></i></p>
30	Offset Inching 2 **	10 - 100	100	<p><b>Inching operation 2</b> The inching speed in inching mode 2 can be influenced via this parameter. Values are in percentage of parameter no. 9. <b>Caution!</b> This parameter is not saved in the EEPROM. <i>CAN-Bus chapter 7.12.2: Object 2450<sub>h</sub></i></p>
31	d – Pos *	1 – 101	101	<p><b>Delay in positioning operation:</b> values in % (100 % <math>\Rightarrow</math> 4 U/s<sup>2</sup>) Value 101: Delay is determined by parameter no 4. <i>CAN-Bus chapter 7.12.2: Object 2410<sub>h</sub> <math>\Rightarrow</math> Subindex 0A<sub>h</sub></i></p>

Table 6: Parameter description

## 7 Communication via CAN bus

### 7.1 General remarks

This chapter describes activation and parameterization via CAN bus interface. For the connector pin assignment of the CAN bus interface please refer to the Installation instructions.

#### 7.1.1 Interface

The AG03/1 supports the following baud rates:

- 15.625 kBd, 20 kBd, 25 kBd, 40 kBd, 50 kBd, 62.5 kBd, 100 kBd, 125 kBd, 200 kBd, 250 kbd, 500 kBd, 1000 kBd

#### Termination of the CAN bus line:

If the AG03/1 is at the end of the bus, the CAN bus connection must be terminated by a defined bus terminator. For the AG03/1 this is achieved by means of an internal terminating resistor which can be switched in via DIP switches SW9 + SW10 (see *chapter 7.15: CAN bus terminator*).

### 7.2 CANopen protocol

The CANopen protocol is based on the CANopen communication profile *CiA DS-301 V4.0* as well as the device profile *Drives and Motion Control CiA DSP-402 V2.0*.

The details required for a better understanding and possible deviations are included in this documentation.

#### 7.2.1 Telegram setup

The data telegram of a CAN message consists of the following fields:

#### SOF:

Start of Frame ⇒ start bit of the telegram

#### Identifier:

The Identifier field contains the identifier as well as bits for the recognition of the length of the identifiers (11 or 29 bits). The identifier determines the priority of the message.

Via identifier, CANopen determines additionally the device address, channel selection as well as data direction.

#### Control field:

contains bits concerning the number of user data and determines whether a data frame or RTR frame (Remote Transfer Request frame) is concerned.

#### Data field:

contains up to 8 bytes of user data. The user data has a different meaning depending on the channel selection.

#### CRC:

contains bits for error detection.

#### ACK/EOF:

The ACK/EOF field contains telegram acknowledgement bits as well as bits for determining the end of telegram.



Fig. 15: Telegram setup

For a detailed description of the telegram please refer to the comprehensive CAN literature. For simplification, only identifier and data field will be dealt with in the subsequent telegram descriptions.

## 7.2.2 Network management (NMT)

The master configures, manages and monitors network nodes via the NMT service.

For switching between the four available communication states of a network node, 'INITIALISATION', 'PRE-OPERATIONAL', 'OPERATIONAL' and 'STOPPED', telegrams with the identifier '0' as well as 2 bytes of user data are used.

The identifier of the NMT protocol is limited to 11 bits.

### 7.2.2.1 State Diagramm

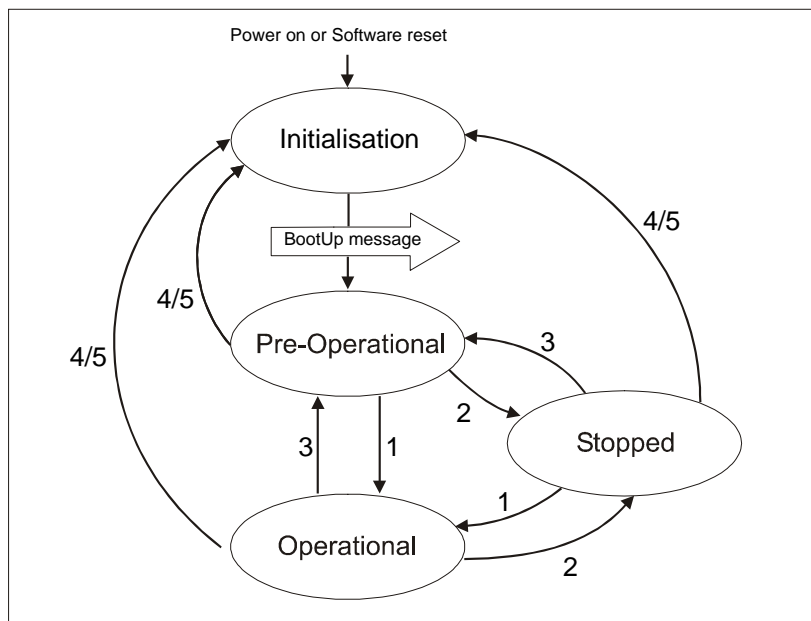

Fig. 16: State Diagramm

### 7.2.2.2 NMT Status 'INITIALISATION'

The AG03/1 is not involved in the bus actions in this state. All hardware and software components are initialised. This state is attained after switching on the device or after receipt of the command code 82<sub>h</sub> of the own or global addresses. After completion of initialisation, the AG03/1 goes automatically into the 'PRE-OPERATIONAL' status. This is signalled by a boot-up message consisting of the identifier '1791 + Node ID' and a data byte having the value '0'.

### 7.2.2.3 NMT Status 'PRE-OPERATIONAL'

The exchange of parameterization data (SDOs) between the AG03/1 and the bus master is enabled. However, no process data (PDOs) is transferred. Furthermore, the State Machine of the AG03/1 is set to the 'SWITCH ON DISABLED' state (see chapter 7.3) and the motor enabled.

<b>NOTICE</b>	PDO parameters can be changed in this state only!
---------------	---

### 7.2.2.4 NMT Status 'OPERATIONAL'

Exchange of process and parameterization data is enabled.  
Hint: TPDOs with the 254 type of transmission are sent with transition to the 'OPERATIONAL' NMT status.

### 7.2.2.5 NMT Status 'STOPPED'

Exchange of all data is stopped with the exception of the heartbeat message (see chapter 7.2.10) and the node guarding protocol, if active (see chapter 7.2.11). Only NMT communication is enabled. Furthermore, the State Machine of the AG03/1 is set to the 'SWITCH ON DISABLED' state (see chapter 7.3) and the motor enabled.

### 7.2.2.6 Switching between communication states

The network master can switch between the communication states by sending the following telegrams with the identifier '0'.

Status change		Data 1	Data 2
from	to		
PRE-OPERATIONAL / STOPPED	OPERATIONAL (1)	01h	xx
OPERATIONAL / PRE-OPERATIONAL	STOPPED (2)	02h	xx
OPERATIONAL / STOPPED	PRE-OPERATIONAL (3)	80h	xx
OPERATIONAL / PRE-OPERATIONAL / STOPPED	INITIALISATION (4/5)	81h	xx
OPERATIONAL / PRE-OPERATIONAL / STOPPED	INITIALISATION * (4/5)	82h	xx

Table 17: Switching between communication states

\* Cold start is triggered (power on)

xx = 0                                   ⇒ the telegram is intended for all devices on the bus  
xx = device address               ⇒ the telegram is only intended for the device with the respective address.

### 7.2.3 SYNC object

CANopen enables the simultaneous query of all inputs and the simultaneous setting of all outputs. The synchronization telegram (SYNC), a CAN message with high priority, which contains no user data serves for this purpose.

The identifier of the Sync object can be set via object 1005<sub>h</sub> (see chapter 7.12.2: Description of objects).

### 7.2.4 Process Data Objects (PDOs)

Process data objects serve for fast exchange of short process data. Process data objects are transferred event-triggered, cyclically or on request. A maximum of 8 bytes of user data can be transferred in a PDO.

<b>NOTICE</b>	The exchange of PDOs is enabled in the NMT status ‚OPERATIONAL‘ only!
---------------	---

The AG03/1 provides 3 Transmit PDOs (process data from the AG03/1 ⇒ NMT master) and 3 Receive PDOs (process data from the NMT master ⇒ to the AG03/1).

The Receive PDOs, RPDO1, RPDO3, RPDo4 and the Transmit PDOs, TPDO1, TPDO3 and TPDO4 are supported according to the Device Profil ‘Drives and Motion Control CIA DSP-402 Version 2.0‘.

### 7.2.5 Transmit PDOs

#### 7.2.5.1 1<sup>st</sup> Transmit PDO (TPDO1)

The first Transmit PDO contains 2 user data bytes on which the status word of the AG03/1 is mapped.

The Transmit PDO is transferred by the AG03/1 asynchronously as a standard. Together with the Receive PDO1 on which the control word of the state machine is mapped it forms a handshake connection (acknowledgement operation) between the higher-order control and the drive controller.

It is, therefore not recommended to change the transfer type of the TDO1.

The COB-ID of the first Transmit PDO is programmed to 180<sub>h</sub> + Node-ID by default. The communication parameters are set via the object 1800<sub>h</sub> (1<sup>st</sup> Transmit PDO parameter).

1 <sup>st</sup> Transmit PDO		
11 / 29 bit identifier	byte 1	byte 2
	LSB	MSB
	status word (object 6041 <sub>h</sub> )	

Fig. 17: 1<sup>st</sup> Transmit PDO

### 7.2.5.2 3<sup>rd</sup> Transmit PDO (TPDO3)

The third Transmit PDO contains 6 user data bytes on which the status word and the current position value of the AG03/1 are mapped.

The Transmit PDO3 is transferred only by a RTR frame (remote transfer request) as a standard, i. e., a higher-order control must request the TDO3 (polling). Synchronous transfer (value 0 to 240) can be set via the SYNC object or the time-triggered transfer (value 255) by means of a local cycle (event timer) as an alternative to polling.

The COB-ID of the third Transmit PDO is programmed to  $380_h + \text{Node-ID}$  by default. The communication parameters are set via the object  $1802_h$  (3<sup>rd</sup> Transmit PDO parameter).

3 <sup>rd</sup> Transmit PDO						
11/29 bit identifier	byte 1	byte 2	byte 3	byte 4	byte 5	byte 6
	LSB	MSB	LSB	NSB	NSB	MSB
	status word (object $6041_h$ )			position value (object $6064_h$ )		

Fig. 18: 3<sup>rd</sup> Transmit PDO

### 7.2.5.3 4<sup>th</sup> Transmit PDO (TPDO4)

The fourth Transmit PDO contains 6 user data bytes on which the status word and the actual velocity of the AG03/1 is mapped.

The Transmit PDO4 is transferred only by a RTR frame (remote transfer request) as a standard, i. e., a higher-order control must request the TDO4 (polling). Synchronous transfer (value 0 to 240) can be set via the SYNC object or the time-triggered transfer (value 255) by means of a local cycle (event timer) as an alternative to polling.

The COB-ID of the fourth Transmit PDO is programmed to  $480_h + \text{Node-ID}$  by default. The communication parameters are set via the object  $1803_h$  (4<sup>th</sup> Transmit PDO parameter).

4 <sup>th</sup> Transmit PDO						
11/29 bit identifier	byte 1	byte 2	byte 3	byte 4	byte 5	byte 6
	LSB	MSB	LSB	NSB	NSB	MSB
	status word (object $6041_h$ )			actual velocity (object $606C_h$ )		

Fig. 19: 4<sup>th</sup> Transmit PDO

### 7.2.5.4 Transfer types of the Transmit PDOs

Different transfer types can be set for the individual PDOs via objects  $1800_h$  until  $1803_h$  'Transmit PDO Parameter' sub-index 2 (see chapter 7.12.2: Description of objects).

#### Synchronous:

Sub-index 2 (transfer type) = 0:

The Transmit PDO is sent by the AG03/1 upon receipt of each SYNC telegram.

Sub-index 2 (transfer type) = 1...240:

The Transmit PDO is sent by the AG03/1 only after receipt of the number of SYNC telegrams indicated under 'transfer type'.

### Asynchronous:

Event-Triggered: Sub-index 2 (transfer type) = 254:

A PDO is transmitted time-controlled with every change of a mapped object. The event timer can be deactivated.

Time-Triggered: Sub-index 2 (transfer type) = 255:

The PDOs are transferred time-triggered.

The sub-index 5 'Event Timer' of the Transmit PDO parameters indicates the cycle time in milliseconds.

Sub-index 2 (transfer type) = 253:

The Transmit PDO is sent after receipt of a RTR frame with the identifier of the respective Transmit PDO.

## 7.2.6 Receive PDOs

### 7.2.6.1 1<sup>st</sup> Receive PDO (RPDO1)

The first Receive PDO contains 2 user data bytes on which the status word of the AG03/1 is mapped.

The control word in the Receive PDO1 serves for controlling the operation transitions of the state machine. The Receive PDO1 serves for getting the state machine into the OPERATION ENABLED state or for commanding travel interruption or cancellation of travel during running drive movement, respectively.

The drive controller processes the Receive PDO1 asynchronously as a standard. Together with the Transmit PDO1 on which the control word of the state machine is mapped it forms a handshake connection (acknowledgement operation) between the higher-order control and the drive controller.

It is, therefore not recommended to change the transfer type of the RPDO1.

The COB-ID of the first Receive PDO is programmed to 200<sub>h</sub> + Node-ID by default.

The communication parameters are set via the object 1400<sub>h</sub> (1<sup>st</sup> Receive PDO parameter).

1 <sup>st</sup> Receive PDO		
11 / 29 bit identifier	byte 1	byte 2
	LSB	MSB
	control word (object 6040 <sub>h</sub> )	

Fig. 20: 1<sup>st</sup> Receive PDO

### 7.2.6.2 3<sup>rd</sup> Receive PDO (RPDO3)

The third Receive PDO is assigned to the operation mode 'Profile Position Mode' (positioning mode) and contains 6 user data bytes on which the control word as well as the current target value for the AG03/1 is mapped.

The position transferred is taken over as the absolute target position. Drive movement in the positioning mode can be executed from the 'OPERATION ENABLED' state of the state machine only.

The drive controller processes the Receive PDO3 asynchronously as a standard.



Together with the Transmit PDO1 on which the status word of the state machine is mapped, it forms a handshake connection (acknowledgement operation) between the higher-order control and the drive controller.

Synchronous transfer type (value 0) can be set to enable synchronous start of more than one drive. The data of the RPDO3 is processed only after receipt of the next SYNC telegram in this case (see chapter 7.2.3: Sync object).

The COB-ID of the third Transmit PDO is programmed to  $400_h + \text{Node-ID}$  by default. The communication parameters are set via the object  $1402_h$  (3<sup>rd</sup> Receive PDO parameter).

3 <sup>rd</sup> Receive PDO						
11/29 bit identifier	byte 1	byte 2	byte 3	byte 4	byte 5	byte 6
	LSB	MSB	LSB	NSB	NSB	MSB
	control word (object $6040_h$ )			target value (object $607A_h$ )		

Fig. 21: 3<sup>rd</sup> Receive PDO

### 7.2.6.3 4<sup>th</sup> Receive PDO (RPDO4)

The fourth Receive PDO is assigned to the operation mode 'Velocity Mode' and contains 6 user data bytes on which the control word as well as the current target velocity for the AG03/1 are mapped.

A driving movement in positive or negative sense of rotation is started via the control word in the Receive PDO4. Drive movement in the velocity mode can be executed from the 'OPERATION ENABLED' state of the state machine only.

The drive controller processes the Receive PDO4 asynchronously as a standard. Together with the Transmit PDO1 onto which the status word of the state machine is mapped, it forms a handshake connection (acknowledgement operation) between the higher-order control and the drive controller. Synchronous transfer type (value 0) can be set to enable synchronous start of more than one drive. The data of the RPDO4 is processed only after receipt of the next SYNC telegram in this case (see chapter 7.2.3: Sync object).

The COB-ID of the fourth Transmit PDO is programmed to  $500_h + \text{Node-ID}$  by default. The communication parameters are set via the object  $1403_h$  (4<sup>th</sup> Receive PDO parameter).

4 <sup>th</sup> Receive PDO						
11/29 bit identifier	byte 1	byte 2	byte 3	byte 4	byte 5	byte 6
	LSB	MSB	LSB	NSB	NSB	MSB
	control word (object $6040_h$ )			target velocity (object $60FF_h$ )		

Fig. 22: 4<sup>th</sup> Receive PDO

### 7.2.6.4 Transfer types of the Receive PDOs

Different transfer types can be set for the individual PDOs via objects  $1400_h$  until  $1403_h$  'Receive PDO Parameter' sub-index 2 (see chapter 7.12.2: Description of objects).

#### Synchronous:

Sub-index 2 (transfer type) = 0...240

In the synchronous transfer type, the Receive PDOs are processed only after receipt of a SYNC telegram.

### Asynchronous:

Sub-index 2 (transfer type) = 254...255

In the asynchronous transfer type, the Receive PDOs are processed by the AG03/1 immediately after receipt of the Receive PDO.

## 7.2.7 Service Data Objects (SDOs)

Service Data Objects (SDOs) serve in the first place for transferring device configuration parameters.

8 bytes of user data are always transferred in a SDO. The identifier is set to 11 bits and cannot be changed.

<b>NOTICE</b>	The exchange of SDOs is enabled in the NMT status ‚PRE-OPERATIONAL‘ as well as ‚OPERATIONAL‘!
---------------	---

There is each one COB ID for data transfer from the master to the AG03/1 (COB-ID 600<sub>h</sub> + Node ID) and one COB ID for data transfer from the AG03/1 to the master (COB-ID 580<sub>h</sub> + Node-ID).

Data transfer is always initiated and controlled by the master.

The COB IDs for the Service Data Objects cannot be changed.

SDO-Telegramm								
11 bit identifier	byte 1	byte 2	byte 3	byte 4	byte 5	byte 6	byte 7	byte 8
	command	parameter index	sub-index	data 1	data 2	data 3	data 4	

Fig. 23: Setup of the SDO telegram

### Byte 1: Command code

The first byte contains the command code of the SDO telegram. The following table lists the available commands and describes their meaning.

Command	Command code hexadecimal	Command code decimal	Meaning
Write Request	23 <sub>h</sub>	35	send parameters to the AG03/1 (4 data byte)
Write Request	2B <sub>h</sub>	43	send parameters to the AG03/1 (2 data byte)
Write Request	2F <sub>h</sub>	47	send parameters to the AG03/1 (1 data byte)
Write Response	60 <sub>h</sub>	96	response of the AG03/1 to Write Request
Read Request	40 <sub>h</sub>	64	request of a parameter by the AG03/1
Read Response	43 <sub>h</sub>	67	response to the request (4 data byte)
Read Response	4B <sub>h</sub>	75	response to the request (2 data byte)
Read Response	4F <sub>h</sub>	79	response to the request (1 data byte)
Error Response	80 <sub>h</sub>	128	error message

Table 18: Command codes

### Bytes 2/3: Parameter index

The parameter index is entered in the user data byte 2 (low byte) and in the user data byte 3 (high byte) using their Intel data format. Here, the index of the object to be parameterized is entered (see chapter 7.12.2: Description of objects).

### Byte 4: Sub-index

The sub-index indicates the number of the fields for objects realized as an array.

### Bytes 5...8: Data area

In the data area, the value of the parameter is entered in left-aligned Intel notation. Byte 5 = low-Byte ... Byte 8 = high Byte

#### 7.2.7.1 Error code

The AG03/1 sends an error response (byte 1 = 80<sub>h</sub>) if a communication error has occurred. An error code is entered in the user data bytes (bytes 5 ... 8).

The table below shows the supported error codes of the AG03/1.

Command code	Data 1	Data 2	Data 3	Data 4	Meaning
80 <sub>h</sub>	11 <sub>h</sub>	00 <sub>h</sub>	09 <sub>h</sub>	06 <sub>h</sub>	Sub-index does not exist.
80 <sub>h</sub>	02 <sub>h</sub>	00 <sub>h</sub>	01 <sub>h</sub>	06 <sub>h</sub>	Attempt to write read-only object.
80 <sub>h</sub>	01 <sub>h</sub>	00 <sub>h</sub>	01 <sub>h</sub>	06 <sub>h</sub>	Attempt to read write-only object.
80 <sub>h</sub>	30 <sub>h</sub>	00 <sub>h</sub>	09 <sub>h</sub>	06 <sub>h</sub>	Value range of parameter exceeded.
80 <sub>h</sub>	36 <sub>h</sub>	00 <sub>h</sub>	09 <sub>h</sub>	06 <sub>h</sub>	Maximum value is less than minimum value.
80 <sub>h</sub>	00 <sub>h</sub>	00 <sub>h</sub>	02 <sub>h</sub>	06 <sub>h</sub>	Object does not exist.
80 <sub>h</sub>	00 <sub>h</sub>	00 <sub>h</sub>	01 <sub>h</sub>	06 <sub>h</sub>	Unsupported access to an object.
80 <sub>h</sub>	22 <sub>h</sub>	00 <sub>h</sub>	00 <sub>h</sub>	08 <sub>h</sub>	Data cannot be transferred to the application because of the present device state.

Table 19: Error codes

#### 7.2.8 Example: Parameterization

The following 2 examples are intended to illustrate parameterization of the AG03/1 via Service Data Objects.

##### 7.2.8.1 Example: Read parameter

The AG03/1 has device address 5 and the calibration value is to be read out!

Calculation of the identifier:

Identifier of the parameter channel to the AG03/1 = 600<sub>h</sub> + device address

$$600_{\text{h}} = 1536_{\text{dec}}$$

$$\text{Identifier} = 1536 + 5 = 1541 = 605_{\text{h}}$$

Command code = Read request (= request of a parameter from the AG03/1) = 40<sub>h</sub>.

$$\text{Index} = 607\text{C}_{\text{h}}$$

The index of the parameter 'Calibration value was taken from the directory of objects (*chapter 7.12.2: Description of objects*).

Sub-index = 0

The current calibration value is 2500 = 9C4<sub>h</sub>.

Telegram from the master to the AG03/1:

Identifier	Byte 1	Byte 2	Byte 3	Byte 4	Byte 5	Byte 6	Byte 7	Byte 8
605 <sub>h</sub>	40 <sub>h</sub>	7C <sub>h</sub>	60 <sub>h</sub>	00 <sub>h</sub>	00 <sub>h</sub>	00 <sub>h</sub>	00 <sub>h</sub>	00 <sub>h</sub>

Response of the AG03/1:

Identifier	Byte 1	Byte 2	Byte 3	Byte 4	Byte 5	Byte 6	Byte 7	Byte 8
585 <sub>h</sub>	42 <sub>h</sub>	7C <sub>h</sub>	60 <sub>h</sub>	00 <sub>h</sub>	C4 <sub>h</sub>	09 <sub>h</sub>	00 <sub>h</sub>	00 <sub>h</sub>

Command code = Read Response = 42<sub>h</sub>

Calculation of the identifier:

Identifier of the parameter channel from the AG03/1 to the master = 580<sub>h</sub> + device address

580<sub>h</sub> = 1408<sub>dec</sub>

Identifier = 1408 + 5 = 1413 = 585<sub>h</sub>

### 7.2.8.2 Example: Write parameter

For the AG03/1 with device address 5 the limit 1 is to be set to 2000000!

Calculation of the identifier:

Identifier of the parameter channel to the AG03/1 = 600<sub>h</sub> + device address

600<sub>h</sub> = 1536<sub>dec</sub>

Identifier = 1536 + 5 = 1541 = 605<sub>h</sub>

Command code = Write request (send parameter to the AG03/1) = 23<sub>h</sub>

Index = 607D<sub>h</sub>

Sub-index = 2

The index and the sub-index of the parameter 'limit 1' were taken from the directory of objects (*chapter 7.12.2: Description of objects*).

2000000 = 1E8480<sub>h</sub>

Telegram from the master to the AG03/1:

Identifier	Byte 1	Byte 2	Byte 3	Byte 4	Byte 5	Byte 6	Byte 7	Byte 8
605 <sub>h</sub>	23 <sub>h</sub>	7D <sub>h</sub>	60 <sub>h</sub>	02 <sub>h</sub>	80 <sub>h</sub>	84 <sub>h</sub>	1E <sub>h</sub>	00 <sub>h</sub>

Response of the AG03/1 in the case of error-free execution:

Identifier	Byte 1	Byte 2	Byte 3	Byte 4	Byte 5	Byte 6	Byte 7	Byte 8
585 <sub>h</sub>	60 <sub>h</sub>	7D <sub>h</sub>	60 <sub>h</sub>	02 <sub>h</sub>	00 <sub>h</sub>	00 <sub>h</sub>	00 <sub>h</sub>	00 <sub>h</sub>

Command code = Write Response = 60<sub>h</sub>

Calculation of the identifier:

Identifier of the parameter channel from the AG03/1 to the master = 580<sub>h</sub> + device address

580<sub>h</sub> = 1408<sub>dec</sub>

Identifier =  $1408 + 5 = 1413 = 585_h$

### 7.2.9 Emergency Object (EMCY)

In the case of an error, the node status is transferred via high-priority emergency messages (emergency telegrams). These telegrams have a data length of 8 bytes and contain error information.

The emergency telegram is transferred as soon as the AG03/1 goes into the fault state (*for the causes of faults refer to chapter 5.2: Faults*) or when a communication error has occurred (*see table 20 Error codes 8120<sub>h</sub> – 8140<sub>h</sub>*).

Resolution of the cause of fault and resetting of the AG03/1 with undoing the fault state are signalled by sending of an emergency telegram with the error code 0000<sub>h</sub> (no error) (not applicable to error code 8140<sub>h</sub>).

The cause of the fault is deposited in the fault buffer (*see object 1003<sub>h</sub>*).

Setup of the emergency telegram.

Identifier	Byte 0	Byte 1	Byte 2	Byte 3	Byte 4	Byte 5	Byte 6	Byte 7
11/29 Bit	Emergency Error Code ( <i>see chapter 7.2.9.1</i> )		Error Register (Object 1001 <sub>h</sub> )	Manufacturer-specific error field (not used)				

Fig. 24: Emergency protocol

The identifier of the emergency object is set to 128 + Node-ID by default; however, it can be changed via object 1014<sub>h</sub> (*see chapter 7.12.2: Description of objects*).

Transfer of an emergency telegram is enabled in the NMT statuses 'OPERATIONAL' or 'PRE-OPERATIONAL' only!

#### 7.2.9.1 Error Code

The following table contains the possible error codes of the emergency telegram:

Error Code		Meaning
Byte 0 (Highbyte)	Byte 1 (Lowbyte)	
00	00 <sub>h</sub>	No error (no fault present) Is sent after clearing the fault state. ( <i>see chapter 5.2: Faults</i> )
21	00 <sub>h</sub>	Current on device input side ( <i>overcurrent: see chapter 5.2.1 ⇒ value 'C'</i> ) The state machine was set to the 'Fault' state. Fault is deposited in the fault buffer.
31	20 <sub>h</sub>	Mains under voltage ( <i>Undervoltage: see chapter 5.2.1 ⇒ value 'A'</i> ) The state machine was set to the 'Fault' state. Fault is deposited in the fault buffer.
32	10 <sub>h</sub>	DC link over-voltage ( <i>Overvoltage: see chapter 5.2.1 ⇒ value 'G'</i> ) The state machine was set to the 'Fault' state. Fault is deposited in the fault buffer.
43	10 <sub>h</sub>	Excess temperature drive ( <i>Overtemperature in output stage: see chapter 5.2.1 ⇒ value 'D'</i> ) The state machine was set to the 'Fault' state. Fault is deposited in the fault buffer.

Error Code		Meaning
Byte 0 (Highbyte)	Byte 1 (Lowbyte)	
71	21 <sub>h</sub>	Motor blocked (Drive shaft blocked: see chapter 5.2.1 ⇒ value 'B') The state machine was set to the 'Fault' state. Fault is deposited in the fault buffer.
73	00 <sub>h</sub>	Sensor SIN/COS monitoring The State Machine was set to the Fault state. Fault is stored in the error buffer.
81	20 <sub>h</sub>	The bus status has changed to 'Error Passive' mode. Communication via CANopen is no longer enabled! Will <b>not</b> be stored in the failure buffer.
<a href="#">81</a>	<a href="#">40<sub>h</sub></a>	<a href="#">Recovered from 'Bus Off'.</a> <a href="#">Will not be stored in the failure buffer.</a>
FF	00 <sub>h</sub>	Manufacturer-specific reserved
FF	01 <sub>h</sub>	Manufacturer-specific (Internal error: see chapter 5.2.1 ⇒ value 'F') The state machine is set to the 'Fault' state. Fault is deposited in the fault buffer.
FF	02 <sub>h</sub>	Manufacturer-specific During active positioning, the bus status 'Error Passive' has occurred. The State Machine was set to the 'Fault' state. Cause of failure is stored in the failure buffer. See chapter 5.2.1 ⇒ value 'H'. Communication via CANopen is no longer enabled!
FF	03 <sub>h</sub>	Manufacturer-specific Bus Status has changed to 'Bus Off' The State Machine was set to the 'Fault' state. Cause of failure is stored in the failure buffer. See chapter 5.2.1 ⇒ value 'I'. Communication via CANopen is no longer enabled!
FF	09 <sub>h</sub>	Manufacturer-specific Battery Undervoltage The State Machine was set to the Fault state. Fault is stored in the error buffer.

Tab. 20: Error Code

### 7.2.10 Heartbeat protocol

The master monitors the state of the AG03/1 via heartbeat protocol. While doing this, the AG03/1 sends cyclically its NMT status.

The AG03/1 sends the heartbeat telegram independently, without request via RTR frame. The AG03/1 is a heartbeat producer, it does not receive nor process heartbeat protocols.

The cycle time of the heartbeat telegram is set via object 1017<sub>h</sub> (see chapter 7.12.2: Description of objects).

The heartbeat protocol is deactivated if the cycle time is 0.

The heartbeat protocol consists of one byte.

Identifier	Byte1
11 bit	status

Fig. 25: Heartbeat protocol



Status = 0: 'INITIALISATION'  
 Status = 4: 'STOPPED'  
 Status = 5: 'OPERATIONAL'  
 Status = 127: 'PRE-OPERATIONAL'

The identifier of the heartbeat protocol is permanently set to 1792 + Node-ID and cannot be changed.  
 Heartbeat telegram are sent in the NMT statuses 'OPERATIONAL', 'PRE-OPERATIONAL' or 'STOPPED'.

<b>NOTICE</b>	The heartbeat protocol is only enabled when node guarding is deactivated!
---------------	---

### 7.2.11 Node Guarding

Node-guarding or life-guarding mechanisms are available for failure monitoring of the CANopen network. Via node guarding the nodes are monitored that can detect a failure of the master. During guarding, the master transmits remote frames (remot transmit request, message request telegrams) on the guarding identifiers of the nodes to be monitored. The latter respond with the guarding message containing the current status of the slave as well as a toggle bit which must change after each message.

The master assumes that a node error as occurred if status or toggle bits do not correspond with those expected by the master.

Via the objects 100C<sub>h</sub> (Guard Time), 100D<sub>h</sub> (Life Time Factor) the time interval (life time) is set within which the AG03/1 expects a node query (RTR frame with the COB-ID 1792 + Node-ID) by the NMT master.

The time interval 'Life time' is calculated from the cycle time 'Guard time' multiplied with the factor 'Life Time Factor'.

The AG03/1 State Machine switches to the 'SWITCH ON DISABLED' state if the AG03/1 receives no RTR frame from the master during the 'Life Time'.

By sending the first RTR frame of the master to the AG03/1, Node Guarding of the AG03/1 is activated after switching on.

Node Guarding is deactivated if the value of either object (100C<sub>h</sub>/100D<sub>h</sub>) is zero.

The response of the AG03/1 to the RTR frame of the master consists of one byte of user data.

Identifier	Byte 1	
11 bit	bit 7: toggle Bit	bit 6 ... 0: status

Fig. 26: Node-Guarding Telegram

#### Toggle Bit:

The toggle bit must alternate between two subsequent responses of the AG03/1.  
 The value of the toggle bit with the first response of the AG03/1 is 0 after activation of the guarding protocol.

#### Status:

Status = 0: 'INITIALISATION'  
 Status = 4: 'STOPPED'  
 Status = 5: 'OPERATIONAL'  
 Status = 127: 'PRE-OPERATIONAL'

The identifier of the heartbeat protocol is permanently set to 1792 + Node-ID and cannot be changed.

A node guard telegram can be sent in the NMT statuses 'OPERATIONAL', 'PRE-OPERATIONAL' or 'STOPPED'.

<b>NOTICE</b>	The node-guard protocol is only enabled when heartbeat protocol is deactivated!
---------------	---

### 7.3 State Machine

In the status word, the CANopen state machine indicates operational and error states of the drive resulting from operational transitions.

The states of the state machine can change via control word (see chapter 7.5) or due to internal events (e. g., occurrence of a fault). The current state of the state machine can be read via the status word (see chapter 7.4: Table 22).

<b>NOTICE</b>	The states of the State Machine can be set 'OPERATIONAL' in the NMT status only!
---------------	--

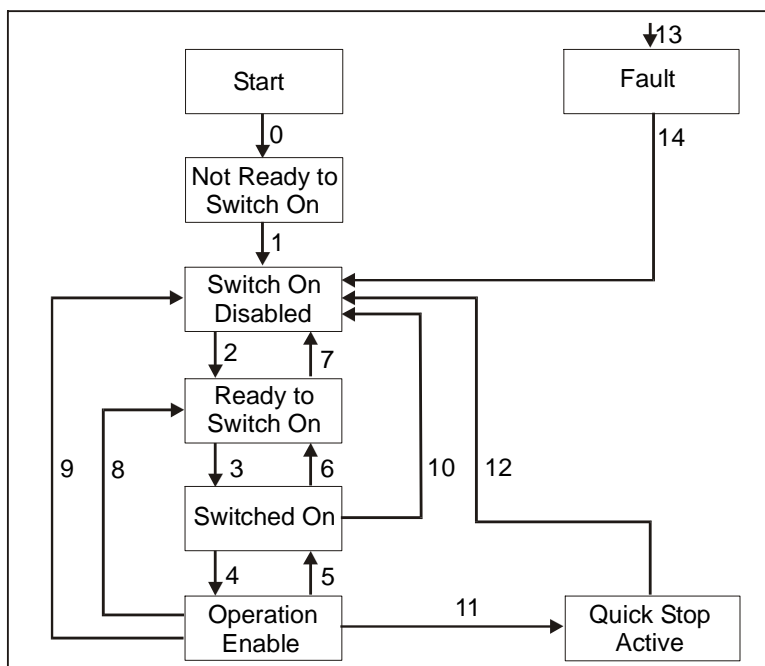

Fig. 27: State machine

The following states of the state machine of the AG03/1 are available:

- 'NOT READY TO SWITCH ON'  
The AG03/1 is being initialized after switching on.  
No travel commands can be accepted.  
Motor is enabled
- 'SWITCH ON DISABLED'  
Initialization completed.  
No travel commands can be accepted.  
Motor is enabled



- 'READY TO SWITCH ON'  
No travel commands can be accepted.  
Motor is enabled
- 'SWITCHED ON'  
No travel commands can be accepted.  
Motor is enabled
- 'OPERATION ENABLED'  
Travel commands can be accepted.  
Motor is in control state.
- 'QUICK STOP ACTIVE'  
The Quick Stop command was executed.  
Motor decelerates with maximum deceleration and stops with stop torque.  
Current positioning is cancelled.  
No travel commands can be accepted.
- 'FAULT'  
An error has occurred.  
Motor is enabled  
Current positioning is cancelled.  
No travel commands can be accepted.

The states of the State Machine can be changed via internal events or through commands of the master via control word (see *table 24*).

- State change 0: START ⇒ NOT READY TO SWITCH ON  
Power on or software reset of the AG03/1
- State change 1: NOT READY TO SWITCH ON ⇒ SWITCH ON DISABLED  
Initialization and self-test of the AG03/1 successfully completed.
- State change 2: SWITCH ON DISABLED ⇒ READY TO SWITCH ON  
'Shut-down' command by master
- State change 3: READY TO SWITCH ON ⇒ SWITCHED ON  
'Switch-On' command by master
- State change 4: SWITCHED ON ⇒ OPERATION ENABLE  
'Enable Operation' command by master
- State change 5: OPERATION ENABLE ⇒ SWITCHED ON  
'Disable Operation' command by master
- State change 6: SWITCHED ON ⇒ READY TO SWITCH ON  
'Shut-down' command by master
- State change 7: READY TO SWITCH ON ⇒ SWITCH ON DISABLED  
'Disable Voltage' command by master
- State change 8: OPERATION ENABLE ⇒ READY TO SWITCH ON  
'Shut-down' command by master
- State change 9: OPERATION ENABLE ⇒ SWITCH ON DISABLED  
'Disable Voltage' command by master

- State change 10: SWITCHED ON ⇒ SWITCH ON DISABLED  
'Disable Voltage' command by master
- State change 11: OPERATION ENABLE ⇒ QUICK STOP ACTIVE  
'Quick-Stop' command by master
- State change 12: QUICK STOP ACTIVE ⇒ SWITCH ON DISABLED  
'Disable Voltage' command by master
- State change 13: All states ⇒ FAULT  
A fault has occurred
- State change 14: FAULT ⇒ SWITCH ON DISABLED  
'Fault Reset' command by master

## 7.4 Status word

The status word reflects the current status of the AG03/1. It consists of 16 bits and is mapped on object 6041<sub>h</sub> and on the 3 Transmit PDO's.

Status word															
15	14	13	12	11	10	9	8	7	6	5	4	3	2	1	0
MSB								LSB							
High Byte								Low Byte							

Fig. 28: Status word

The following table lists the designations of the individual bits of the status word and their meanings.

Bit	Designation	Description
0	Ready to switch on	indicates the state of the State Machine (see table 22)
1	Switched on	indicates the state of the State Machine (see table 22)
2	Operation enabled	indicates the state of the State Machine (see table 22)
3	Fault	indicates the state of the State Machine (see table 22)
4	Voltage enabled	bit 4 is set when the supply voltage is within the tolerance limit
5	Quick stop	indicates the state of the State Machine (see table 22) bit 5 is set when the AG03/1 is not in the 'QUICK STOP ACTIVE' state.
6	Switch on disabled	indicates the state of the State Machine (see table 22)
7	Warning	bit 7 is set when a warning is active (see chapter 5.1: Warnings).
8	Profile Position Mode: show readiness for travel	bit 8 is set if the State Machine is in the 'OPERATION ENABLED' state und the follwing conditions are met: <ul style="list-style-type: none"> <li>• no fault present</li> <li>• Supply voltage of the output stage is applied</li> <li>• no limit have been exceeded</li> <li>• no active travel job</li> </ul>
	Profile Velocity Mode: show readiness for travel	Bit 8 is set if the State Machine is in the 'OPERATION ENABLED' state und the follwing conditions are met: <ul style="list-style-type: none"> <li>• no fault present</li> <li>• no active travel job</li> <li>• Supply voltage of the output stage is applied</li> </ul>
9	Remote	Bit 9 is set when the AG03/1 is in the NMT status 'OPERATIONAL' or 'STOPPED'. The AG03/1 receives commands via CAN interface in this case.

Bit	Designation	Description
10	Profile Position Mode: Target reached	Bit 10 is set when the drive has come to a stop at the pre-defined target position within the defined window after a successfully executed positioning command.
	Profile Velocity Mode: Target reached	Bit 10 is set when the actual speed is within the defined window of the target speed.
11	internal Limit	Bit 11 is set when the upper or lower limits have been exceeded.
12	Profile Position Mode: Set Point Acknowledged	Bit 12 is set when the drive controller has started a travel command in the positioning mode. A travel job is started via bit 'New Setpoint' in the control word ( <i>object 6040<sub>n</sub>, control word bit 4</i> ) (value 0 ⇒ 1). Subsequently, the controller firmware plausibilizes the target position, the operation and control parameters and the local state of the drive and sets bit 12 after the check has been passed successfully. Bit 12 is deleted when bit 4 in the control word has been reset to zero following a positioning job (Clear new setpoint).
	Profile Velocity Mode: Speed	Bit 12 is set when the drive stands still.
13	reserved	statically on 0
14	Profile Position Mode: Pos active	Bit 14 is set when there is an active positioning job in the operation mode 'Profile Position Mode' (positioning mode). <b>Attention!</b> No new setpoint is accepted and travelling in inching operation is disabled as long as bit 14 is set!
	Profile Velocity Mode:	no meaning, statically on 0
15	Profile Position Mode: drive travels	The drive shaft of the AG03/1 is moving if bit 15 is set.
	Profile Velocity Mode:	statically on 0

Table 21: Bit description of the status word

The following table represents the possible states of the state machine and the resulting bit values.

The field containing an x are irrelevant for the states of the state machine.

State	Bit 7	Bit 6	Bit 5	Bit 4	Bit 3	Bit 2	Bit 1	Bit 0
Not Ready to Switch On	x	0	x	x	0	0	0	0
Switch On Disabled	x	1	x	x	0	0	0	0
Ready to Switch On	x	0	1	x	0	0	0	1
Switched On	x	0	1	x	0	0	1	1
Operation Enabled	x	0	1	x	0	1	1	1
Quick Stop Activ	x	0	0	x	0	1	1	1
Fault	x	0	x	x	1	0	0	0

Table 22: Low byte status word States of the state machine

## 7.5 Control word

The control word consists of 16 bits and is mapped on the object 6040<sub>h</sub>, and in the 3 Receive PDOs.

It contains bits for controlling the state machine as well as controlling the operational modes, Profile Position Mode (positioning mode) and Profile Velocity Mode (velocity mode).

Control word															
15	14	13	12	11	10	9	8	7	6	5	4	3	2	1	0
MSB High Byte								Low Byte LSB							

Fig. 29: Control word

The following table lists the designations of the individual bits of the control word and their meanings.

Bit	Designation	Description
0	Switch on	controls the state of the State Machine (see table 24)
1	Disable voltage	controls the state of the State Machine (see table 24)
2	Quick stop	controls the state of the State Machine (see table 24)
3	Enable operation	controls the state of the State Machine (see table 24)
4	Profile Position Mode: New Setpoint	By bit 4, positioning is triggered in the drive controller in the OPERATION ENABLED state (value 0 $\Rightarrow$ 1). The drive controller acknowledges the travel command via bit 12 'Setpoint acknowledged' in the status word (see chapter 7.4).
	Profile Velocity Mode:	no meaning
5	reserved	
6	reserved	
7	Fault reset	If the state machine of the AG03/1 is in the FAULT state, the fault is reset by an edge on bit 7 (0 $\Rightarrow$ 1) and the state machine is set to the SWITCH ON DISABLED state on the condition that the cause of the fault has been resolved in advance (see chapter 5.2: Faults).
8	Profile Position Mode: Stop	By setting bit 8 on value 1, interruption of travel can be triggered during a running positioning event. Motor runs out with programmed deceleration and stops in the control state. Positioning is resumed and completed after resetting the bit (value 1 $\Rightarrow$ 0).
	Profile Velocity Mode: Stop	By bit 8, drive movement is triggered in the velocity mode in the OPERATION ENABLED state (value 1 $\Rightarrow$ 0).
9	reserved	
10	reserved	
11	reserved	
12	reserved	
13	Profile Position Mode: Inching operation 1	Inching operation 1 is started by an edge change (value 0 $\Rightarrow$ 1) on bit 13 (see chapter 2.2.1.2: Inching operation).
	Profile Velocity Mode:	no meaning
14	Profile Position Mode: Inching operation 2 positive	Inching operation 2 is started in positive travel direction by an edge change (value 0 $\Rightarrow$ 1) on bit 14 (see chapter 2.2.1.2: Inching operation). The drive travels in positive direction until bit 14 has been deleted.
	Profile Velocity Mode:	no meaning
15	Profile Position Mode: Inching operation 2 negative	Inching operation 2 is started in negative travel direction by an edge change (value 0 $\Rightarrow$ 1) on bit 15 (see chapter 2.2.1.2: Inching operation). The drive travels in negative direction until bit 15 has been deleted.
	Profile Velocity Mode:	no meaning

Table 23: Bit description of the control word

The following table shows the control of the state machine with the bit combinations of the control word required.

The fields containing an x are irrelevant for the control of the state machine.

Command	Bit 7	Bit 6	Bit 5	Bit 4	Bit 3	Bit 2	Bit 1	Bit 0
Shutdown	0	x	x	x	x	1	1	0
Switch On	0	x	x	x	0	1	1	1
Disable Voltage	0	x	x	x	x	x	0	x
Quick Stop	0	x	x	x	x	0	1	x
Disable Operation	0	x	x	x	0	1	1	1
Enable Operation	0	x	x	x	1	1	1	1
Fault Reset	0 ⇒ 1	x	x	x	x	x	x	x

Table 24: Low Byte Control word<sub>h</sub> control of state machine

<b>NOTICE</b>	<ul style="list-style-type: none"> <li>- PDOs are enabled in the NMT status 'OPERATIONAL' only.</li> <li>- Travel commands are enabled in the 'OPERATION ENABLED' state of the State machine.</li> </ul>
---------------	--



### 7.6 Flowchart of the Profile Position Mode (positioning mode)

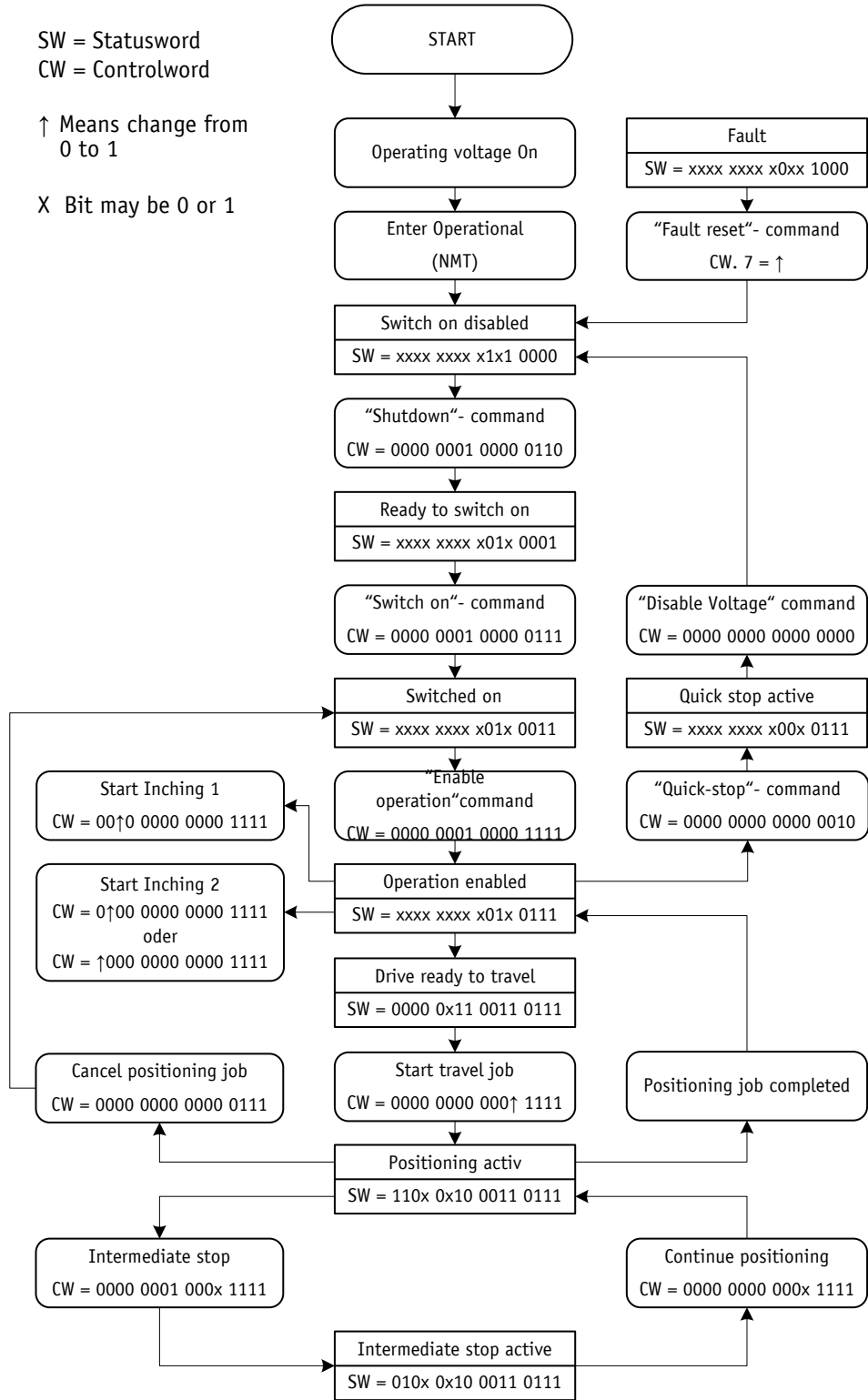

Fig. 30: Flowchart of the Profile Position Mode (positioning mode)



### 7.7 Flowchart of the Profile Velocity Mode operation mode (velocity mode)

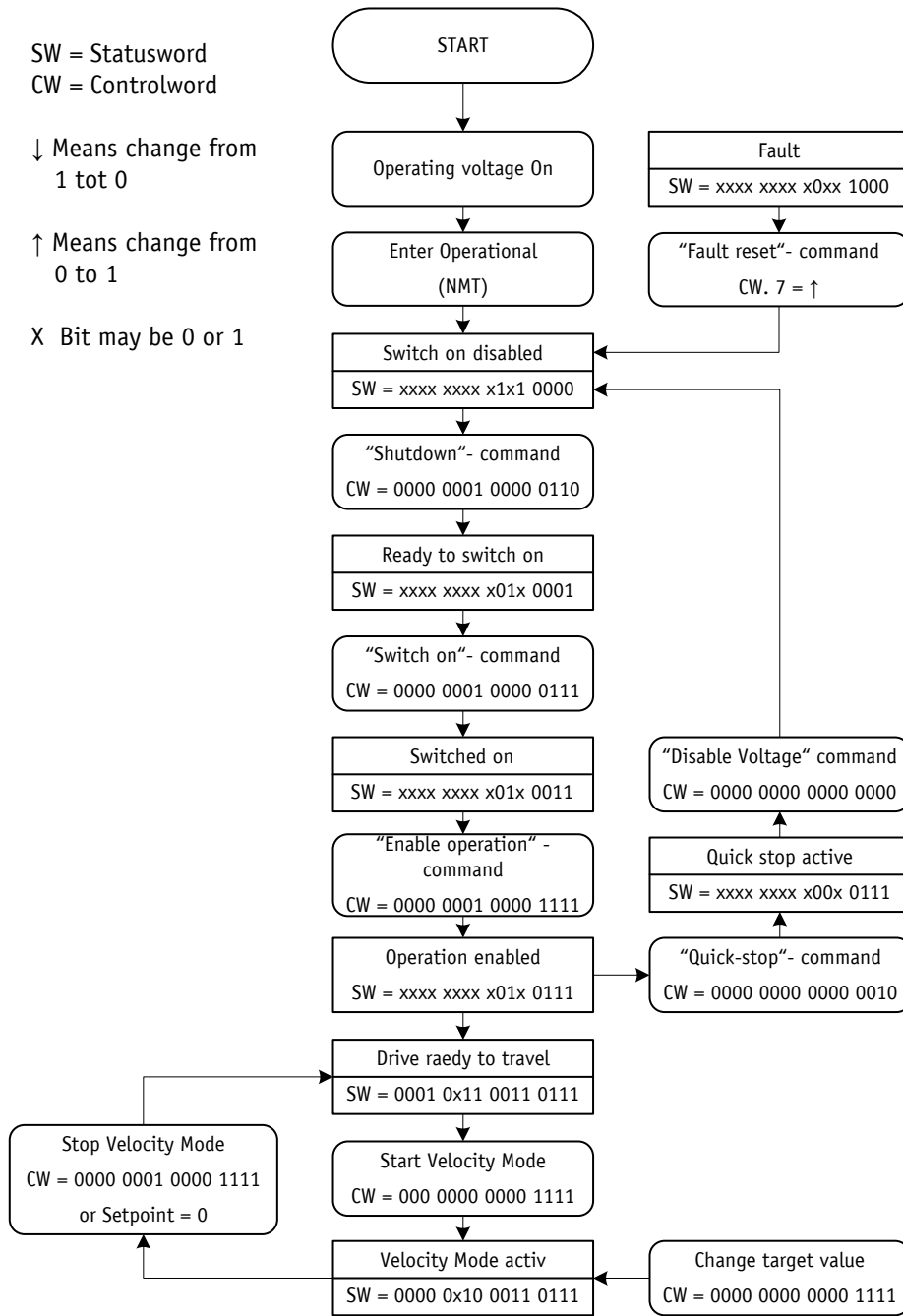

Fig. 31: Flowchart of the Profile Velocity Mode (velocity mode)

## 7.8 Examples

### 7.8.1 Example of the Profile Position Mode (positioning mode)

In the following table a positioning example in the Profile Position Mode (positioning mode) is represented.

The node address of the AG03/1 is 5 in this example.

Identifier	Message	Meaning
0x000	0x01 0x05	NMT: Enter OPERATIONAL
0x205	0x06 0x01	RPDO1: Shutdown command
0x205	0x07 0x01	RPDO1: Switch On command
0x205	0x0F 0x01	RPDO1: Enable Operation command
0x405	0x1F 0x00 0x88 0x13 0x00 0x00	RPDO3: Travel to position +5000
-	-	wait until target position has been reached
0x205	0x0F 0x01	RPDO1: clear New Setpoint
0x405	0x1F 0x00 0x78 0xEC 0xFF 0xFF	RPDO3: Travel to position -5000
0x205	0x1F 0x01	RPDO1: Intermediate stop
0x205	0x1F 0x00	RPDO1: continue positioning
-	-	wait until target position has been reached
0x205	0x0F 0x01	RPDO1: clear New Setpoint
0x205	0x07 0x01	RPDO1: Disable Operation command
0x205	0x06 0x01	RPDO1: Shutdown command
0x205	0x00 0x01	RPDO1: Disable Voltage command
0x000	0x80 0x05	NMT: Enter PRE-OPERATIONAL

Table 25: Positioning example in Profile Position Mode:

### 7.8.2 Example of the Profile Velocity Mode (velocity mode)

In the following table an example in the Profile Velocity Mode (velocity mode) is represented.

The node address of the AG03/1 is 5 in this example.

Operating mode change via parameter 20, chapter 6: parameter description (Default: Profile Position Mode).

Identifier	Message	Meaning
0x000	0x01 0x05	NMT: Enter OPERATIONAL
0x205	0x06 0x01	RPDO1: Shutdown command
0x205	0x07 0x01	RPDO1: Switch On command
0x205	0x0F 0x01	RPDO1: Enable Operation command
0x505	0x0F 0x00 0x44 0x00 0x00 0x00	RPDO4: Start of velocity mode with the target speed of +68 rev/min positive sense of rotation
-	-	wait until target speed has been reached
0x505	0x0F 0x00 0x1E 0x00 0x00 0x00	RPDO4: Change of velocity to +30 rev/min
0x205	0x0F 0x01	RPDO1: Stop drive movement
0x505	0x0F 0x00 0xB8 0xFF 0xFF 0xFF	RPDO4: Start of velocity mode with the target speed of -72 rev/min (negative sense of rotation)
-	-	wait until target speed has been reached
0x205	0x0F 0x01	RPDO1: Stop drive movement
0x205	0x07 0x01	RPDO1: Disable Operation command
0x205	0x06 0x01	RPDO1: Shutdown command
0x205	0x00 0x01	RPDO1: Disable Voltage command
0x000	0x80 0x05	NMT: Enter PRE-OPERATIONAL

Table 26: Example of Profile Velocity Mode



## 7.9 Overview of CANopen identifiers

The following table offers an overview of the identifiers used in the AG03/1.

Default identifier (hexadecimal)	Default identifier (decimal)	Description	Own setting
0	0	Network management (NMT)	
80	128	SYNC – Message	
80 + Node-ID	128 + Node-ID	Emergency Message	
180 + Node-ID	384 + Node-ID	TPDO1	
200 + Node-ID	512 + Node-ID	RPDO1	
380 + Node-ID	896 + Node-ID	TPDO3	
400 + Node-ID	1024 + Node-ID	RPDO3	
480 + Node-ID	1152 + Node-ID	TPDO4	
500 + Node-ID	1280 + Node-ID	RPDO4	
580 + Node-ID	1408 + Node-ID	SDO (tx)	
600 + Node-ID	1536 + Node-ID	SDO (rx)	
700 + Node-ID	1792 + Node-ID	Heartbeat Message	
700 + Node-ID	1792 + Node-ID	Node-Guard Message	

Table 27: Overview of identifiers

## 7.10 Setting the CAN baud rate

The CAN baud rate is entered via Object 2100<sub>h</sub> (CAN baud rate).  
The baud rate is factory-set to 500kbaud.

## 7.11 EDS file

The EDS file SIKOAG03/1.EDS (electronic data sheet) is available for the AG03/1.  
This file enables easy integration and configuration of the AG03/1 in a CANopen network using commercial CANopen configurations.

## 7.12 Directory of objects

Every CANopen device keeps a directory of objects where all parameters of the device are deposited in the form of object entries. The object entries can be accessed via SDO communication services (*see chapter 7.2.7*). Thus, a parameter can be read (SDO upload) and written (SDO download) if permitted by the object entry access rights or the state of the device, respectively.

The following index ranges are used:

1000 <sub>h</sub> - 1FFF <sub>h</sub>	objects of the communication profile CIA DS-301 V4.0.
2000 <sub>h</sub> - 5FFF <sub>h</sub>	manufacturer-specific object entries.
6000 <sub>h</sub> - 9FFF <sub>h</sub>	objects of the device profile CIA DSP-402 V2.0.

### 7.12.1 Overview of objects

The following table offers an overview of the objects of the AG03/1.

Index	Name	Description
1000 <sub>h</sub>	Device type	The object indicates the device profile number of the AG03/1.
1001 <sub>h</sub>	Error register	The object shows error states of the AG03/1.
1002 <sub>h</sub>	Manufacturer Status Register	Contains the system status word of the AG03/1 ( <i>see chapter 2.1</i> )
1003 <sub>h</sub>	Pre-Defined Error Field	The object stores up to 10 error messages.
1005 <sub>h</sub>	COB-ID Sync Message	Setting of the COB ID of the SYNC object.
1008 <sub>h</sub>	Manufacturer Device Name	Indicates the device name.
100A <sub>h</sub>	Manufacturer Software Version	Indicates the software version of the controller firmware.
100C <sub>h</sub>	Guard Time	Setting of the 'Guard Time' for the Node Guarding protocol ( <i>see chapter 7.2.11</i> ).
100D <sub>h</sub>	Life Time Factor	Setting of the time interval 'Life Time' ( <i>see chapter 7.2.11</i> ).
1011 <sub>h</sub>	Restore Default Parameters	Restoration of factory-set states of the changeable parameters and calibration of the AG03/1 ( <i>see chapter 3: Calibration</i> ).
1014 <sub>h</sub>	COB-ID Emergency Message	Setting of the COB ID of the Emergency object.
1017 <sub>h</sub>	Producer Heartbeat Time	Setting of the cycle time for the heartbeat protocol ( <i>see chapter 7.2.10</i> ).
1018 <sub>h</sub>	Identity Objekt	Contains the Vendor ID of the device manufacturer.
1200 <sub>h</sub>	Server SDO Parameter	Contains the COB IDs of the default server SDO.
1400 <sub>h</sub>	1 <sup>st</sup> Receive PDO Parameter	Setting of the communication parameters of the RPDO1.
1402 <sub>h</sub>	3 <sup>rd</sup> Receive PDO Parameter	Setting of the communication parameters of the RPDO3.
1403 <sub>h</sub>	4 <sup>th</sup> Receive PDO Parameter	Setting of the communication parameters of the RPDO4.
1600 <sub>h</sub>	1 <sup>st</sup> Receive PDO Mapping Parameter	Contains the objects mapped on the RPDO1 ( <i>see chapter 7.2.6.1</i> ).
1601 <sub>h</sub>	2 <sup>nd</sup> Receive PDO Mapping Parameter	Compatibility entry
1602 <sub>h</sub>	3 <sup>rd</sup> Receive PDO Mapping Parameter	Contains the objects mapped on the RPDO3 ( <i>see chapter 7.2.6.2</i> ).
1603 <sub>h</sub>	4 <sup>th</sup> Receive PDO Mapping Parameter	Contains the objects mapped on the RPDO4 ( <i>see chapter 7.2.6.3</i> ).
1800 <sub>h</sub>	1 <sup>st</sup> Transmit PDO parameter	Setting of the communication parameters of the TPDO1.
1801 <sub>h</sub>	2 <sup>nd</sup> Transmit PDO Parameter	Compatibility entry
1802 <sub>h</sub>	3 <sup>rd</sup> Transmit PDO Parameter	Setting of the communication parameters of the TPDO3.
1803 <sub>h</sub>	4 <sup>th</sup> Transmit PDO Parameter	Setting of the communication parameters of the TPDO4.
1A00 <sub>h</sub>	1 <sup>st</sup> Transmit PDO Mapping Parameter	Contains the objects mapped on the TPDO1 ( <i>see chapter 7.2.5.1</i> ).
1A01 <sub>h</sub>	2 <sup>nd</sup> Transmit PDO Mapping Parameter	Compatibility entry
1A02 <sub>h</sub>	3 <sup>rd</sup> Transmit PDO Mapping Parameter	Contains the objects mapped on the TPDO3 ( <i>see chapter 7.2.5.2</i> ).

Index	Name	Description
1A03 <sub>h</sub>	4 <sup>th</sup> Transmit PDO Mapping Parameter	Contains the objects mapped on the TPDO4 (see chapter 7.2.5.3).
2100 <sub>h</sub>	Can-Baud rate	Setting of the CAN baud rate of the AG03/1.
2101 <sub>h</sub>	Node-ID	Setting of the node address of the AG03/1.
2102 <sub>h</sub>	Transfer reduction	Contains the gear reduction of the AG03/1.
2410 <sub>h</sub>	Motor Parameter Set	Setting of the control parameters of the drive controller (see chapter 6: Parameter description).
2412 <sub>h</sub>	Spindle Pitch Set	Setting of the spindle pitch (see chapter 6: Parameter 13).
2413 <sub>h</sub>	Pos Type Set	Setting of the positioning type (see chapter 6: Parameter 19).
2415 <sub>h</sub>	Delta Jog Set	Setting of the travel distance in inching operation 1 (see chapter 6: Parameter 17).
2416 <sub>h</sub>	Stop Mode Inching Mode 2	Setting of the stop behaviour in inching operation 2.
2417 <sub>h</sub>	Inpos Mode	Setting of the behaviour upon reaching the positioning window.
2418 <sub>h</sub>	Loop Length	Setting the loop length (see chapter 6: Parameter 27).
241B <sub>h</sub>	Power Supply Voltage	Supply voltage of output stage and control
241C <sub>h</sub>	Output Stage Temperature	Temperature of output stage
241E <sub>h</sub>	Motor Current	Current motor current
2420 <sub>h</sub>	Generic Status Register	Indicates the state of supply voltage of the output stage and of torque disable.
2421 <sub>h</sub>	Torque Deactivation	Setting of torque deactivation.
2422 <sub>h</sub>	Torque Deactivation State	State of torque deactivation.
2423 <sub>h</sub>	Battery Voltage	Current battery voltage
2450 <sub>h</sub>	Inching 2 Offset	Offset value in inching operation 2
2500 <sub>h</sub>	Production Date	Contains the drive's production date.
6040 <sub>h</sub>	Controlword	Contains the control word of the state machine for drives
6041 <sub>h</sub>	Statusword	Contains the status word of the state machine for drives.
6060 <sub>h</sub>	Modes of Operation	Setting of the operation mode: Profile Position Mode / Profile Velocity Mode (see chapter 6: Parameter 20).
6064 <sub>h</sub>	Position Actual Value	Contains the absolute actual position in the operation mode Profile Position Mode (positioning mode).
6067 <sub>h</sub>	Position Window	Setting of the tolerance window (see chapter 6: Parameter 10).
606C <sub>h</sub>	Velocity Actual Value	Contains the actual velocity in the operation mode Profile Velocity Mode (velocity mode).
607A <sub>h</sub>	Target Position	Contains the target position in the operation mode Profile Position Mode (positioning mode).
607C <sub>h</sub>	Calibration Value	Calibration of the AG03/1 (see chapter 6: Parameter 14 and chapter 3: Calibration).
607D <sub>h</sub>	Software Position Limit	Setting of the limits (see chapter 6: Parameter 15/16).
607E <sub>h</sub>	Polarity	Setting of the polarity (sense of rotation) of the AG03/1 (see chapter 6: Parameter 18).
6091 <sub>h</sub>	Gear Ratio	Setting of gear ratio (see chapter 6: Parameter 11/12).
60FF <sub>h</sub>	Target Velocity	Contains the target velocity in the operation mode Profile Velocity Mode (velocity mode).

Table 28: Overview of objects

### 7.12.2 Description of objects

Below, all objects of the positioning drive AG03/1 are described sorted by their indexes.

### 7.12.2.1 1000<sub>h</sub>: Device Type

Object 1000<sub>h</sub> indicates the device profile number.

Subindex	00 <sub>h</sub>
Description	Information on the device profile
Access	read-only
PDO mapping	no
Data type	Unsigned32
Default	00000192 <sub>h</sub>
EEPROM	no

Format description:

Bit 31 - 24	Manufacturer-specific (not used)
Bit 23 - 16	drive type (not used)
Bit 15 - 0	device profile number

### 7.12.2.2 1001<sub>h</sub>: Error Register

Object 1001<sub>h</sub> indicates the error state of the device.

Subindex	00 <sub>h</sub>
Description	current error code
Access	read-only
PDO mapping	no
Data type	Unsigned8
Default	no
EEPROM	no

Format description:

Bit 7	Manufacturer-specific error
Bit 6	reserved (statically 0)
Bit 5	Drive shaft blocked
Bit 4	Error during data transfer
Bit 3	Temperature
Bit 2	Voltage
Bit 1	Current
Bit 0	General error (is set when error is present)

A detailed error evaluation can be attained via object 1003<sub>h</sub> (Predefined Error Field). Faults and errors are signalled at the time of their occurrence by an emergency message (see *chapter 7.2.9: Emergency Object*).

### 7.12.2.3 1002<sub>h</sub>: Manufacturer Status Register

Object 1002<sub>h</sub> indicates the system status word of the AG03/1 (see chapter 2.1: System Status Word).

Subindex	00 <sub>h</sub>
Description	Manufacturer-specific status register
Access	read-only
PDO mapping	no
Data type	Unsigned16
Default	no
EEPROM	no

Format description:

Bit 31 -16	not used
Bit 15 - 0	see chapter 2.1: System Status Word

### 7.12.2.4 1003<sub>h</sub>: Pre-defined Error Field

Object 1003<sub>h</sub> stores the last 10 causes of faults.  
 The entry under sub-index 00<sub>h</sub> contains the number of faults currently stored.  
 The latest fault message is stored under sub-index 01<sub>h</sub>.  
 Writing a '0' on sub-index 00<sub>h</sub> resets the fault buffer.

Subindex	00 <sub>h</sub>
Description	number of fault messages
Access	read-write
PDO mapping	no
Data type	Unsigned8
Default	0
EEPROM	no
Value range	0 ... 10

Subindex	01 <sub>h</sub> ... 0A <sub>h</sub>
Description	faults that occurred
Access	read-only
PDO mapping	no
Data type	Unsigned16
Default	no
EEPROM	yes

Format description:

Bit 31 - 16	not used
Bit 15 - 8	error code high byte (see chapter 7.2.9.1)
Bit 7 - 0	error code low byte (see chapter 7.2.9.1)

### 7.12.2.5 1005<sub>h</sub>: COB-ID Sync Message

The COB-ID of the SYNC object is set via object 1005<sub>h</sub>.  
The SYNC message is sent to all network participant (broadcast object).

Subindex	00 <sub>h</sub>
Description	COB ID SYNC message
Access	read-write
PDO mapping	no
Data type	Unsigned32
Default	80 <sub>h</sub>
EEPROM	no

Format description:

Bit 31 - 30	not used
Bit 29	0 = 11-bit identifier (CAN 2.0A) 1 = 29-bit identifier (CAN 2.0B)
Bit 28 - 11	if bit 29=1, bit 28 ... 11 of the 29-bit identifier
Bit 10 - 0	bit 10 ... 0 of the identifier

<b>NOTICE</b>	The COB-ID of the Sync message can be changed in the NMT status 'PREOPERATIONAL' only!
---------------	--

### 7.12.2.6 1008<sub>h</sub>: Manufacturer Device Name

Object 1008<sub>h</sub> indicates the device name.

Subindex	00 <sub>h</sub>
Description	Device name in ASCII characters
Access	read-only
PDO mapping	no
Data type	Unsigned32 (max. 4 characters)
Default	no
EEPROM	no

Format description (example):

Bit 7 - 0	41 <sub>h</sub> = ' A ' (ASCII character, ISO 8859)
Bit 15 - 8	47 <sub>h</sub> = ' G ' (ASCII character, ISO 8859)
Bit 23 - 16	30 <sub>h</sub> = ' 0 ' (ASCII character, ISO 8859)
Bit 31 - 24	33 <sub>h</sub> = ' 3 ' (ASCII character, ISO 8859)

Device name = AG03/1

### 7.12.2.7 100A<sub>h</sub>: Manufacturer Software Version

Object 100A<sub>h</sub> indicates the software version of the controller firmware.

Subindex	00 <sub>h</sub>
Description	Software version as ASCII characters
Access	read-only
PDO mapping	no
Data type	Unsigned32 (max. 4 characters)
Default	no
EEPROM	no

Format description (example):

Bit 7 - 0	31 <sub>h</sub> = ' 1 ' (ASCII character, ISO 8859)
Bit 15 - 8	2E <sub>h</sub> = ' . ' (ASCII character, ISO 8859)
Bit 23 - 16	30 <sub>h</sub> = ' 0 ' (ASCII character, ISO 8859)
Bit 31 - 24	30 <sub>h</sub> = ' 0 ' (ASCII character, ISO 8859)

Software version = V.1.00

### 7.12.2.8 100C<sub>h</sub>: Guard Time

The cycle time 'Guard Time' for node guarding is set via object 100C<sub>h</sub>.  
The cycle time 'Guard Time' is given in milliseconds (see chapter 7.2.11: Node Guarding).

Subindex	00 <sub>h</sub>
Description	Guard Time
Access	read-write
PDO mapping	no
Unit	milliseconds
Data type	Unsigned16
Default	no
EEPROM	no

Data description:

Value '0' means that node guarding is deactivated.

### 7.12.2.9 100D<sub>h</sub>: Life Time Factor

The time interval 'Life Time' for life guarding is set via object 100D<sub>h</sub> (see chapter 7.2.11: Node Guarding).

Subindex	00 <sub>h</sub>
Description	Life Time Factor
Access	read-write
PDO mapping	no
Data type	Unsigned8
Default	0
EEPROM	no

Data description:

Value '0' means that Life Guarding is deactivated.

### 7.12.2.10 1011<sub>h</sub>: Restore Default Parameters

The default values of the changeable parameters can be retrieved via object 1011<sub>h</sub>. Parameter ranges are specified by selecting the respective subindex.

Sub-index 01<sub>h</sub>: set all parameters to default values

Sub-index 02<sub>h</sub>: set only standard parameters to default values.

Sub-index 03<sub>h</sub>: set only control parameters to default values.

Sub-index 04<sub>h</sub>: calibrate the AG03/1

Subindex	00 <sub>h</sub>
Description	Number of subindexes
Access	read-only
PDO mapping	no
Data type	Unsigned8
Default	4
EEPROM	no

Subindex	01 <sub>h</sub>
Description	set all parameters to default values
Access	write-only
PDO mapping	no
Data type	Unsigned32
Default	no
EEPROM	no

Subindex	02 <sub>h</sub>
Description	set standard parameters to default values
Access	write-only
PDO mapping	no
Data type	Unsigned32
Default	no
EEPROM	no

Subindex	03 <sub>h</sub>
Description	set controller parameters to default values
Access	write-only
PDO mapping	no
Data type	Unsigned32
Default	no
EEPROM	no

Subindex	04 <sub>h</sub>
Description	calibrate the AG03/1
Access	write-only
PDO mapping	no
Data type	Unsigned32
Default	no
EEPROM	no



Format description sub-index 01<sub>h</sub> – 04<sub>h</sub>:

Bit 31 - 24	64 <sub>h</sub> = ' d ' (ASCII character, ISO 8859)
Bit 23 - 16	61 <sub>h</sub> = ' a ' (ASCII character, ISO 8859)
Bit 15 - 8	6F <sub>h</sub> = ' o ' (ASCII character, ISO 8859)
Bit 7 - 0	6C <sub>h</sub> = ' l ' (ASCII character, ISO 8859)

By writing the signature 'load' to a sub-index 0...3, the factory settings (see chapter 6: *Parameter description* ⇒ *Default column*) of the respective parameters are retrieved. By writing the signature 'load' to sub-index 04, the AG03/1 is calibrated (see chapter 3: *Calibration*).

<b>NOTICE</b>	Parameter Bus address or CAN baud rate are not changed by retrieval of the factory settings!
---------------	--

### 7.12.2.11 1014<sub>h</sub>: COB-ID Emergency Message

The COB-ID of the Emergency object is set via object 1014<sub>h</sub> (see chapter 7.2.9: *Emergency Object*).

Subindex	00 <sub>h</sub>
Description	COB ID of the Emergency Message
Access	read-write
PDO mapping	no
Data type	Unsigned32
Default	80 <sub>h</sub> + Node-ID
EEPROM	no

Format description:

Bit 31	0 = EMCY exists / is valid 1 = EMCY does not exist / is not valid
Bit 30	reserved (always 0)
Bit 29	0 = 11-bit identifier (CAN 2.0A) 1 = 29-bit identifier (CAN 2.0B)
Bit 28 -11	if bit 29=1, bit 28 ... 11 of the 29-bit identifier
Bit 10 - 0	bit 10 ...0 of the identifier

<b>NOTICE</b>	The COB-ID of the Emergency message can be changed in the NMT status 'PREOPERATIONAL' only!
---------------	---

### 7.12.2.12 1017<sub>h</sub>: Producer Heartbeat Time

The cycle time 'Heartbeat Time' for the heartbeat protocol is set via object 1017<sub>h</sub>. The 'Heartbeat Time' is given in milliseconds (see chapter 7.2.10: *Heartbeat protocol*).

Subindex	00 <sub>h</sub>
Description	Producer Heartbeat Time
Access	read-write
PDO mapping	no
Unit	milliseconds
Data type	Unsigned16
Default	0
EEPROM	no

Data description:

Value '0' means that the heartbeat protocol is deactivated.

### 7.12.2.13 1018<sub>h</sub>: Identity Objekt

The Vendor ID of the manufacturer is indicated via object 1018<sub>h</sub>.

Subindex	00 <sub>h</sub>
Description	Number of subindexes
Access	read-only
PDO mapping	no
Data type	Unsigned8
Default	1
EEPROM	no

Subindex	01 <sub>h</sub>
Description	Vendor ID
Access	read-only
PDO mapping	no
Data type	Unsigned32
Default	195 <sub>h</sub> (SIKO GmbH)
EEPROM	no

Subindex	02 <sub>h</sub>
Description	Product Code (no function: Compatibility entry)
Access	read-only
PDO mapping	no
Data type	Unsigned32
Default	0
EEPROM	no

Subindex	03 <sub>h</sub>
Description	Revision Number (no function: Compatibility entry)
Access	read-only
PDO mapping	no
Datentyp	Unsigned32
Data type	0
EEPROM	no



Subindex	04 <sub>h</sub>
Description	Serial Number
Access	read-only
PDO mapping	no
Data type	Unsigned32
Default	no
EEPROM	no

Vendor ID:

The Vendor ID is assigned by the CAN user organization CiA e. V. (CAN in Automation). Vendor ID '195<sub>h</sub>' has been assigned to the company SIKO GmbH.

#### 7.12.2.14 1200<sub>h</sub>: Server SDO Parameter

The COB IDs for the Default Server SDO are indicated via object 1200<sub>h</sub> (see also chapter 7.2.7: Service Data Objects).

Subindex	00 <sub>h</sub>
Description	Number of subindexes
Access	read-only
PDO mapping	no
Data type	Unsigned8
Default	2
EEPROM	no

Subindex	01 <sub>h</sub>
Description	COB ID Master ⇒ AG03/1 (rx)
Access	read-only
PDO mapping	no
Data type	Unsigned32
Default	600 <sub>h</sub> + Node-ID
EEPROM	no

Subindex	02 <sub>h</sub>
Description	COB-ID AG03/1 ⇒ Master (tx)
Access	read-only
PDO mapping	no
Data type	Unsigned32
Default	580 <sub>h</sub> + Node-ID
EEPROM	no

Format description:

Bit 31	0 = SDO valid 1 = SDO not valid
Bit 30	reserved (statically 0)
Bit 29	0 = 11-bit identifier (CAN 2.0A) 1 = 29-bit identifier (CAN 2.0B)
Bit 28 - 11	if bit 29=1, bit 28 ... 11 of the 29-bit identifier
Bit 10 - 7	4 bit function code of the identifier
Bit 6 - 0	7 bit Node ID of the identifier

Data description:

The default DSO cannot be changed (according to the CiA DS-301 Predefined Connection Set).

### 7.12.2.15 1400<sub>h</sub>: 1<sup>st</sup> Receive PDO Parameter

The communication parameters of the first Receive PDO (RPDO1) are set via object 1400<sub>h</sub>.

Subindex	00 <sub>h</sub>
Description	largest sub-index supported
Access	read-only
PDO mapping	no
Data type	Unsigned8
Default	2
EEPROM	no

Subindex	01 <sub>h</sub>
Description	COB-ID
Access	read-write (writable in the "Pre-Operational" state)
PDO mapping	no
Data type	Unsigned32
Default	200 <sub>h</sub> + Node-ID
EEPROM	no

Subindex	02 <sub>h</sub>
Description	Transfer type (see chapter 7.2.6.4: Transfer types of Receive PDOs)
Access	read-write (writable in the "Pre-Operational" state)
PDO mapping	no
Data type	Unsigned8
Default	255
EEPROM	no

Subindex	03 <sub>h</sub>
Description	Inhibit Time
Access	read-write (writable in the "Pre-Operational" state)
PDO mapping	no
Data type	Unsigned16
Default	100
EEPROM	no

Subindex	05 <sub>h</sub>
Description	Event Timer (no function: Compatibility entry)
Access	Read-write (writable in the "Pre-Operational" state)
PDO mapping	no
Data type	Unsigned16
Default	0 ... 65535
EEPROM	no

Format description sub-index 01<sub>h</sub>:

Bit 31	0 = PDO exists / is valid 1 = PDO does not exist / is not valid
Bit 30	not used
Bit 29	0 = 11-bit identifier (CAN 2.0A) 1 = 29-bit identifier (CAN 2.0B)
Bit 28 - 11	if bit 29=1, bit 28 ... 11 of the 29-bit identifier
Bit 10 - 7	4 bit function code of the identifier
Bit 6 - 0	7 bit Node ID of the identifier

Data description sub-index 02<sub>h</sub>:

0	synchronous: RPDO1 is processed only after a SYNC message has been received
1 ... 240	synchronous: identical with value 0
241 ... 251	reserved
252	reserved
253	reserved
254	identical with value 255
255	asynchronous: RPDO1 is immediately processed

PDO mapping:

see object 1600<sub>h</sub> (1<sup>st</sup> receive PDO mapping parameter).

Processing of PDOs:

Receive PDOs are processed in the NMT status 'OPERATIONAL' only. It is not recommended to change the transfer type of the RPDO1 since otherwise the functioning of the state machine would no longer be ensured.

Changing PDO parameters:

PDO parameters can be changed in the NMT status 'PRE-OPERATIONAL' only.

### 7.12.2.16 1401<sub>h</sub>: 2<sup>nd</sup> Receive PDO Parameter

Object 1401h was implemented for compatibility reasons only and has no function.

Subindex	00 <sub>h</sub>
Description	largest sub-index supported
Access	read-only
PDO mapping	no
Data type	Unsigned8
Default	5
EEPROM	no

Subindex	01 <sub>h</sub>
Description	COB-ID (no function: Compatibility entry)
Access	read-only
PDO mapping	no
Data type	Unsigned32
Default	301 <sub>h</sub>
EEPROM	no

Subindex	02 <sub>h</sub>
Description	Transmission type (no function: Compatibility entry)
Access	read-only
PDO mapping	no
Data type	Unsigned8
Default	255
EEPROM	no

Subindex	03 <sub>h</sub>
Description	Inhibit Time (no function: Compatibility entry)
Access	read-only
PDO mapping	no
Data type	Unsigned16
Default	0
EEPROM	no

Subindex	05 <sub>h</sub>
Description	Event Timer (no function: Compatibility entry)
Access	read-only
PDO mapping	no
Data type	Unsigned16
Default	0
EEPROM	no

### 7.12.2.17 1402<sub>h</sub>: 3<sup>rd</sup> Receive PDO Parameter

The communication parameters of the third Receive PDO (RPDO3) are set via object 1402<sub>h</sub>.

Subindex	00 <sub>h</sub>
Description	largest sub-index supported
Access	read-only
PDO mapping	no
Data type	Unsigned8
Default	5
EEPROM	no

Subindex	01 <sub>h</sub>
Description	COB-ID
Access	read-write
PDO mapping	no
Data type	Unsigned32
Default	400 <sub>h</sub> + Node-ID
EEPROM	no

Subindex	02 <sub>h</sub>
Description	Transfer type (see chapter 7.2.6.4: Transfer types of Receive PDOs)
Access	read-write
PDO mapping	no
Data type	Unsigned8
Default	255
EEPROM	no

Subindex	03 <sub>h</sub>
Description	Inhibit Time (no function: Compatibility entry)
Access	read
PDO mapping	no
Data type	Unsigned16
Default	0
EEPROM	no

Subindex	05 <sub>h</sub>
Description	Event Timer (no function: Compatibility entry)
Access	read
PDO mapping	no
Data type	Unsigned16
Default	0
EEPROM	no

#### Format description sub-index 01<sub>h</sub>:

Bit 31	0 = PDO exists / is valid 1 = PDO does not exist / is not valid
Bit 30	not used
Bit 29	0 = 11-bit identifier (CAN 2.0A) 1 = 29-bit identifier (CAN 2.0B)
Bit 28 - 11	if bit 29=1, bit 28 ... 11 of the 29-bit identifier
Bit 10 - 7	4 bit function code of the identifier
Bit 6 - 0	7 bit Node ID of the identifier

#### Data description sub-index 02<sub>h</sub>:

0	synchronous: RPDO1 is processed only after a SYNC message has been received
1 ... 240	synchronous: identical with value 0
241 ... 251	reserved
252	reserved
253	reserved
254	identical with value 255
255	asynchronous: RPDO1 is immediately processed

#### PDO mapping:

see object 1602<sub>h</sub> (3<sup>rd</sup> receive PDO mapping parameter).

#### Processing of PDOs:

Receive PDOs are processed in the NMT status 'OPERATIONAL' only.

#### Changing PDO parameters:

PDO parameters can be changed in the NMT status 'PRE-OPERATIONAL' only.

### 7.12.2.18 1403<sub>h</sub>: 4<sup>th</sup> Receive PDO Parameter

The communication parameters of the fourth Receive PDO (RPDO4) are set via object 1403<sub>h</sub>.

Subindex	00 <sub>h</sub>
Description	largest sub-index supported
Access	read-only
PDO mapping	no
Data type	Unsigned8
Default	5
EEPROM	no

Subindex	01 <sub>h</sub>
Description	COB ID
Access	read-write
PDO mapping	no
Data type	Unsigned32
Default	500 <sub>h</sub> + Node-ID
EEPROM	no

Subindex	02 <sub>h</sub>
Description	Transfer type (see chapter 7.2.6.4: Transfer types of Receive PDOs)
Access	read-write
PDO mapping	no
Data type	Unsigned8
Default	255
EEPROM	no

Subindex	03 <sub>h</sub>
Description	Inhibit Time (no function: Compatibility entry)
Access	read
PDO mapping	no
Data type	Unsigned16
Default	0
EEPROM	no

Subindex	05 <sub>h</sub>
Description	Event Timer (no function: Compatibility entry)
Access	read
PDO mapping	no
Data type	Unsigned16
Default	0
EEPROM	no

#### Format description sub-index 01<sub>h</sub>:

Bit 31	<a href="#">0 = PDO exists / is valid</a> <a href="#">1 = PDO does not exist / is not valid</a>
Bit 30	not used
Bit 29	0 = 11-bit identifier (CAN 2.0A) 1 = 29-bit identifier (CAN 2.0B)
Bit 28 - 11	if bit 29=1, bit 28 ... 11 of the 29-bit identifier
Bit 10 - 7	4 bit function code of the identifier
Bit 6 - 0	7 bit Node ID of the identifier

#### Data description sub-index 02<sub>h</sub>:

0	synchronous: RPDO1 is processed only after a SYNC message has been received
1 ... 240	synchronous: identical with value 0
241 ... 251	reserved
252	reserved
253	reserved
254	identical with value 255
255	asynchronous: RPDO1 is immediately processed



PDO mapping:

see object 1603<sub>h</sub> (4<sup>th</sup> receive PDO mapping parameter).

Processing of PDOs:

Receive PDOs are processed in the NMT status 'OPERATIONAL' only.

Changing PDO parameters:

PDO parameters can be changed in the NMT status 'PRE-OPERATIONAL' only.

**7.12.2.19 1600<sub>h</sub>: 1<sup>st</sup> Receive PDO Mapping Parameter**

Object 1600<sub>h</sub> determines the objects that are mapped on the first Receive PDO (RPDO1).

Subindex	00 <sub>h</sub>
Description	Number of mapped application objects in RPDO 1
Access	read-only
PDO mapping	no
Data type	Unsigned8
Default	1
EEPROM	no

Subindex	01 <sub>h</sub>
Description	first object mapped
Access	read-only
PDO mapping	no
Data type	Unsigned32
Default	60400010 <sub>h</sub>
EEPROM	no

Format description sub-index 01<sub>h</sub>:

Bit 31 - 16	Index 16 bits
Bit 15 - 8	Sub-index 8 bits
Bit 7 - 0	8 bits object length

Data description

The object cannot be changed (static mapping).

Mapped objects:

- object 6040<sub>h</sub> (control word) in bytes 0 and 1.

**7.12.2.20 1601<sub>h</sub>: 2<sup>nd</sup> Receive PDO Mapping Parameter**

Object 1601<sub>h</sub> was implemented for compatibility reasons only and has no function.

Subindex	00 <sub>h</sub>
Description	Number of mapped application objects in RPDO 2
Access	read-only
PDO mapping	no
Data type	Unsigned8
Default	0
EEPROM	no

### 7.12.2.21 1602<sub>h</sub>: 3<sup>rd</sup> Receive PDO Mapping Parameter

Object 1602<sub>h</sub> determines the objects that are mapped on the third Receive PDO (RPDO3).

Subindex	00 <sub>h</sub>
Description	Number of mapped application objects in RPDO 3
Access	read-only
PDO mapping	no
Data type	Unsigned8
Default	2
EEPROM	no

Subindex	01 <sub>h</sub>
Description	first object mapped
Access	read-only
PDO mapping	no
Data type	Unsigned32
Default	60400010 <sub>h</sub>
EEPROM	no

Subindex	02 <sub>h</sub>
Description	second object mapped
Access	read-only
PDO mapping	no
Data type	Unsigned32
Default	607A0020 <sub>h</sub>
EEPROM	no

Format description sub-index 01<sub>h</sub> – 02<sub>h</sub>:

Bit 31 -16	index 16 Bit
Bit 15 -8	sub-index 8 bits
Bit 7 0	8 bits object length

#### Data Description:

The object cannot be changed (static mapping).

#### Mapped objects:

- object 6040<sub>h</sub> (control word) in bytes 0 and 1.
- object 607A<sub>h</sub> (target position) in bytes 2 to 5.

### 7.12.2.22 1603<sub>h</sub>: 4<sup>th</sup> Receive PDO Mapping Parameter

Object 1603<sub>h</sub> determines the objects that are mapped on the fourth Receive PDO (RPDO4).

Subindex	00 <sub>h</sub>
Description	Number of mapped application objects in RPDO 4
Access	read-only
PDO mapping	no
Data type	Unsigned8
Default	2
EEPROM	no

Subindex	01 <sub>h</sub>
Description	first object mapped
Access	read-only
PDO mapping	no
Data type	Unsigned32
Default	60400010 <sub>h</sub>
EEPROM	no

Subindex	02 <sub>h</sub>
Description	second object mapped
Access	read-only
PDO mapping	no
Data type	Unsigned32
Default	60FF0020 <sub>h</sub>
EEPROM	no

Format description sub-index 01<sub>h</sub> – 02<sub>h</sub>:

Bit 31 - 16	index 16 bits
Bit 15 - 8	sub-index 8 bits
Bit 7 - 0	8 bits object length

#### Data description:

The object cannot be changed (static mapping).

#### Mapped objects:

- object 6040<sub>h</sub> (control word) in bytes 0 and 1.
- object 60FF<sub>h</sub> (target velocity) in bytes 2 to 5.

### 7.12.2.23 1800<sub>h</sub>: 1<sup>st</sup> Transmit PDO Parameter

The communication parameters of the first Transmit PDO (TPDO1) are set via object 1800<sub>h</sub>.

Subindex	00 <sub>h</sub>
Description	largest sub-index supported
Access	read-only
PDO mapping	no
Data type	Unsigned8
Default	5
EEPROM	no

Subindex	01 <sub>h</sub>
Description	COB-ID
Access	read-write (writable in the "Pre-Operational" state)
PDO mapping	no
Data type	Unsigned32
Default	180 <sub>h</sub> + Node-ID
EEPROM	no

Subindex	02 <sub>h</sub>
Description	Transfer type (see chapter 7.2.5.4: Transfer types of Transmit PDOs)
Access	read-write (writable in the "Pre-Operational" state)
PDO mapping	no
Data type	Unsigned8
Default	255
EEPROM	no

Subindex	03 <sub>h</sub>
Description	Inhibit Time
Access	read-write (writable in the "Pre-Operational" state)
PDO mapping	no
Unit	X 100 μs
Data type	Unsigned16
Default	100
EEPROM	no

Subindex	05 <sub>h</sub>
Description	Event Timer
Access	read-write (writable in the "Pre-Operational" state)
PDO mapping	no
Unit	milliseconds
Data type	Unsigned16
Default	100
EEPROM	yes
Value range	0 ... 65535 The service is switched off by writing the value 0

Format description sub-index 01<sub>h</sub>:

Bit 31	0 = PDO exists / is valid 1 = PDO does not exist / is not valid
Bit 30	0 = request via RTR frame enabled 1 = request via RTR frame disabled
Bit 29	0 = 11-bit identifier (CAN 2.0A) 1 = 29-bit identifier (CAN 2.0B)
Bit 28 - 11	if bit 29=1, bit 28 ... 11 of the 29-bit identifier
Bit 10 - 7	4 bit function code of the identifier
Bit 6 - 0	7 bit Node-ID of the identifier

#### Data description sub-index 02<sub>h</sub>:

0	synchronous: acyclic, PDO is sent after each SYNC message.
1 ... 240	synchronous: cyclic, PDO is sent after 1...240 SYNC messages received.
241 ... 251	reserved
252	reserved
253	asynchronous: on request (RTR frame). PDO is sent immediately after receipt of the RTR frame. <b>Attention!</b> Must have been enabled via bit 30 of sub-index 1.
254	asynchron: Event-Triggered (bei jeder Änderung eines gemappten Objekts und zeitgesteuert)
255	asynchronous: Time-Triggered

#### PDO mapping:

see object 1A00<sub>h</sub> (1<sup>st</sup> transmit PDO mapping parameter).

#### Inhibit Time:

A send-inhibit time is specified by the 'Inhibit Time' parameter (only with transmission time 254). The resolution is a multiple of 100µs. The actual send-inhibit time is inaccurate and can deviate from the set value by several milliseconds.

#### Event Timer:

The 'Event Timer' parameter serves for setting a cycle time (in milliseconds) for time-triggered transfer of the Transmit PDO1. The actual send-inhibit time is inaccurate and can deviate from the set value by several milliseconds.

#### Processing of PDOs:

Transmit PDOs are transferred in the NMT status 'OPERATIONAL' only. It is not recommended to change the transfer type of the TPDO1 since otherwise the functioning of the state machine would no longer be ensured.

#### Changing PDO parameters:

PDO parameters can be changed in the NMT status 'PRE-OPERATIONAL' only.

### 7.12.2.24 1801<sub>h</sub>: 2<sup>nd</sup> Transmit PDO Parameter

Object 1801<sub>h</sub> was implemented for compatibility reasons only and has no function.

Subindex	00 <sub>h</sub>
Description	largest sub-index supported
Access	read-only
PDO mapping	no
Data type	Unsigned8
Default	5
EEPROM	no

Subindex	01 <sub>h</sub>
Description	COB-ID
Access	read-only
PDO mapping	no
Data type	Unsigned32
Default	281 <sub>h</sub>
EEPROM	no

Subindex	02 <sub>h</sub>
Description	Transmission type (no function: Compatibility entry)
Access	read-only
PDO mapping	no
Data type	Unsigned8
Default	255
EEPROM	no

Subindex	03 <sub>h</sub>
Description	Inhibit Time (no function: Compatibility entry)
Access	read-only
PDO mapping	no
v	Unsigned16
Default	0
EEPROM	no

Subindex	05 <sub>h</sub>
Description	Event Timer (no function: Compatibility entry)
Access	read-only
PDO mapping	no
Unit	milliseconds
Data type	Unsigned16
Default	100
EEPROM	no

#### 7.12.2.25 1802<sub>h</sub>: 3<sup>rd</sup> Transmit PDO Parameter

The communication parameters of the third Transmit PDO (TPDO3) are set via object 1802<sub>h</sub> (TPDO3) eingestellt.

Subindex	00 <sub>h</sub>
Description	largest sub-index supported
Access	read-only
PDO mapping	no
Data type	Unsigned8
Default	5
EEPROM	no

Subindex	01 <sub>h</sub>
Description	COB-ID
Access	read-write
PDO mapping	no
Data type	Unsigned32
Default	380 <sub>h</sub> + Node-ID
EEPROM	no

Subindex	02 <sub>h</sub>
Description	Transfer type (see chapter 7.2.5.4: Transfer types of Transmit PDOs)
Access	read-write (writable in the "Pre-Operational" state)
PDO mapping	no
Data type	Unsigned8
Default	253
EEPROM	no

Subindex	03h
Description	Inhibit Time
Access	read-write (writable in the "Pre-Operational" state)
PDO mapping	no
Unit	x 100 µs
Data type	Unsigned16
Default	100
EEPROM	no

Subindex	05 <sub>h</sub>
Description	Event Timer
Access	read-write (writable in the "Pre-Operational" state)
PDO mapping	no
Unit	milliseconds
Data type	Unsigned16
Default	100
EEPROM	no
Value range	0 ... 65535 The service is switched off by writing the value 0.

#### Format description sub-index 01<sub>h</sub>:

Bit 31	0 = PDO exists / is valid 1 = PDO does not exist / is not valid
Bit 30	0 = request via RTR frame enabled 1 = request via RTR frame disabled
Bit 29	0 = 11-bit identifier (CAN 2.0A) 1 = 29-bit identifier (CAN 2.0B)
Bit 28 - 11	if bit 29=1, bit 28 ... 11 of the 29-bit identifier
Bit 10 - 7	4 bit function code of the identifier
Bit 6 - 0	7 bit Node-ID of the identifier

#### Data description sub-index 02<sub>h</sub>:

0	synchronous: acyclic, PDO is sent after each SYNC message.
1 ... 240	synchronous: cyclic, PDO is sent after 1 ... 240 SYNC messages received.
241 ... 251	reserved
252	reserved
253	asynchronous: only on request (RTR frame). PDO is sent immediately after receipt of the RTR frame. <b>Attention!</b> Must have been enabled via bit 30 of sub-index 1.
254	asynchronous: event-triggered (with every change of a mapped object and time-controlled)
255	asynchronous: time-triggered

#### PDO mapping:

see object 1A02<sub>h</sub> (3<sup>rd</sup> transmit PDO mapping parameter).

#### Inhibit Time:

Inhibit Time: A send-inhibit time is specified by the 'Inhibit Time' parameter (only with transmission time 254). The resolution is a multiple of 100µs. The actual send-inhibit time is inaccurate and can deviate from the set value by several milliseconds.

### Event Timer:

The 'Event Timer' parameter serves for setting a cycle time (in milliseconds) for time-triggered transfer of the Transmit PDO3. The actual send-inhibit time is inaccurate and can deviate from the set value by several milliseconds.

### Processing of PDOs:

Transmit PDOs are transferred in the NMT status 'OPERATIONAL' only.

### Changing PDO parameters:

PDO parameters can be changed in the NMT status 'PRE-OPERATIONAL' only.

## 7.12.2.26 1803<sub>n</sub>: 4<sup>th</sup> Transmit PDO Parameter

The communication parameters of the fourth Transmit PDO (TPDO4) are set via object 1803<sub>n</sub>.

Subindex	00 <sub>h</sub>
Description	largest sub-index supported
Access	read-only
PDO mapping	no
Data type	Unsigned8
Default	5
EEPROM	no

Subindex	01 <sub>h</sub>
Description	COB-ID
Access	read-write (writable in the "Pre-Operational" state)
PDO mapping	no
Data type	Unsigned32
Default	480 <sub>h</sub> + Node-ID
EEPROM	no

Subindex	02 <sub>h</sub>
Description	Transfer type (see chapter 7.2.5.4: Transfer types of Transmit PDOs)
Access	read-write (writable in the "Pre-Operational" state)
PDO mapping	no
Data type	Unsigned8
Default	253
EEPROM	no

Subindex	03 <sub>h</sub>
Description	Inhibit Time
Access	read-write (writable in the "Pre-Operational" state)
PDO mapping	no
Unit	x 100 μs
Data type	Unsigned16
Default	100
EEPROM	no



Subindex	05 <sub>h</sub>
Description	Event Timer
Access	read-write (writable in the "Pre-Operational" state)
PDO mapping	no
Unit	milliseconds
Data type	Unsigned16
Default	100
EEPROM	no
Value range	0 ... 65535 The service is switched off by writing the value 0.

#### Format description sub-index 01<sub>h</sub>:

Bit 31	0 = PDO exists / is valid 1 = PDO does not exist / is not valid
Bit 30	0 = request via RTR frame enabled 1 = request via RTR frame disabled
Bit 29	0 = 11-bit identifier (CAN 2.0A) 1 = 29-bit identifier (CAN 2.0B)
Bit 28 - 11	if bit 29=1, bit 28 ... 11 of the 29-bit identifier
Bit 10 - 7	4 bit function code of the identifier
Bit 6 - 0	7 bit Node-ID of the identifier

#### Data description sub-index 02<sub>h</sub>:

0	synchronous: acyclic, PDO is sent after each SYNC message.
1 ... 240	synchronous: cyclic, PDO is sent after 1 ... 240 SYNC messages received.
241 ... 251	reserved
252	reserved
253	asynchronous: only on request (RTR frame). PDO is sent immediately after receipt of the RTR frame. <b>Attention!</b> Must have been enabled via bit 30 of sub-index 1.
254	asynchronous: Event-triggered (with every change of a mapped object and time-controlled)
255	asynchronous: time-triggered

#### PDO mapping:

see object 1A03<sub>h</sub> (4<sup>th</sup> transmit PDO mapping parameter).

#### Inhibit Time:

A send-inhibit time is specified by the 'Inhibit Time' parameter (only with transmission time 254). The resolution is a multiple of 100µs. The actual send-inhibit time is inaccurate and can deviate from the set value by several milliseconds.

#### Event Timer:

The 'Event Timer' parameter serves for setting a cycle time (in milliseconds) for time-triggered transfer of the Transmit PDO4. The actual send-inhibit time is inaccurate and can deviate from the set value by several milliseconds.

### Processing of PDOs:

Transmit PDOs are transferred in the NMT status 'OPERATIONAL' only.

### Changing PDO parameters:

PDO parameters can be changed in the NMT status 'PRE-OPERATIONAL' only.

## 7.12.2.27 1A00<sub>h</sub>: 1<sup>st</sup> Transmit PDO Mapping Parameter

Object 1A00<sub>h</sub> determines the objects that are mapped on the first Transmit PDO (TPDO1).

Subindex	00 <sub>h</sub>
Description	Number of mapped application objects in TPDO 1
Access	read-only
PDO mapping	no
Data type	Unsigned8
Default	1
EEPROM	no

Subindex	01 <sub>h</sub>
Description	first object mapped
Access	read-only
PDO mapping	no
Data type	Unsigned32
Default	60410010 <sub>h</sub>
EEPROM	no

### Format description sub-index 01<sub>h</sub>:

Bit 31 - 16	index 16 bits
Bit 15 - 8	sub-index 8 bits
Bit 7 - 0	8 bits object length

### Data description:

The object cannot be changed (static mapping).

### Mapped objects:

- object 6041<sub>h</sub> (status word) in bytes 0 and 1.

## 7.12.2.28 1A01<sub>h</sub>: 2<sup>nd</sup> Transmit PDO Mapping Parameter

Object 1A01<sub>h</sub> was implemented for compatibility reasons only and has no function.

Subindex	00 <sub>h</sub>
Description	Number of mapped application objects in TPDO 2
Access	read-only
PDO mapping	no
Data type	Unsigned8
Default	0
EEPROM	no

### 7.12.2.29 1A02<sub>h</sub>: 3<sup>rd</sup> Transmit PDO Mapping Parameter

Object 1A02<sub>h</sub> determines the objects that are mapped on the third Transmit PDO (TPDO3).

Subindex	00 <sub>h</sub>
Description	Number of mapped application objects in TPDO 3
Access	read-only
PDO mapping	no
Data type	Unsigned8
Default	2
EEPROM	no

Subindex	01 <sub>h</sub>
Description	first object mapped
Access	read-only
PDO mapping	no
Data type	Unsigned32
Default	60410010 <sub>h</sub>
EEPROM	no

Subindex	02 <sub>h</sub>
Description	second object mapped
Access	read-only
PDO mapping	no
Data type	Unsigned32
Default	60640020 <sub>h</sub>
EEPROM	no

Format description sub-index 01<sub>h</sub> – 02<sub>h</sub>:

Bit 31 - 16	index 16 bits
Bit 15 - 8	sub-index 8 bits
Bit 7 - 0	8 bits object length

Data description:

The object cannot be changed (static mapping).

Mapped objects:

- object 6041<sub>h</sub> (status word) in bytes 0 and 1.
- object 6064<sub>h</sub> (position actual value) in bytes 2 to 5.

### 7.12.2.30 1A03<sub>h</sub>: 4<sup>th</sup> Transmit PDO Mapping Parameter

Object 1A03<sub>h</sub> determines the objects that are mapped on the fourth Transmit PDO (TPDO4).

Subindex	00 <sub>h</sub>
Description	Number of mapped application objects in TPDO 4
Access	read-only
PDO mapping	no
Data type	Unsigned8
Default	2
EEPROM	no

Subindex	01 <sub>h</sub>
Description	first object mapped
Access	read-only
PDO mapping	no
Data type	Unsigned32
Default	60410010 <sub>h</sub>
EEPROM	no

Subindex	02 <sub>h</sub>
Description	second object mapped
Access	read-only
PDO mapping	no
Data type	Unsigned32
Default	606C0020 <sub>h</sub>
EEPROM	no

Format description sub-index 01<sub>h</sub> – 02<sub>h</sub>:

Bit 31 - 16	index 16 bits
Bit 15 - 8	sub-index 8 bits
Bit 7 - 0	8 bits object length

Data description:

The object cannot be changed (static mapping).

Mapped objects:

- object 6041<sub>h</sub> (status word) in bytes 0 and 1.
- object 606C<sub>h</sub> (velocity actual value) in bytes 2 to 5.

### 7.12.2.31 2100<sub>h</sub>: CAN baud rate

The CAN baud rate is set via object 2100<sub>h</sub>.

Subindex	00 <sub>h</sub>
Description	CAN baud rate (see chapter 6: Parameter description ⇒ parameter no. 23)
Access	read-write
PDO mapping	no
Data type	Unsigned8
Default	10
EEPROM	yes
Value range	0 ... 11

Data description:

Value = 0:	15,625	kBaud
Value = 1:	20	kBaud
Value = 2:	25	kBaud
Value = 3:	40	kBaud
Value = 4:	50	kBaud
Value = 5:	62,5	kBaud



Value = 6: 100 kBaud  
 Value = 7: 125 kBaud  
 Value = 8: 200 kBaud  
 Value = 9: 250 kBaud  
 Value = 10: 500 kBaud  
 Value = 11: 1000 kBaud

<b>NOTICE</b>	Baud rate change is only possible in PRE-OPERATIONAL NMT-status!
---------------	--

<b>NOTICE</b>	The baud rate is taken over only after the next initialization of the positioning drive! The Master must be adjusted to the new baud rate as well!
---------------	---

### 7.12.2.32 2101<sub>n</sub>: Node-ID

The set node ID of the AG03/1 can be read via object 2101<sub>n</sub>.

Subindex	00 <sub>h</sub>
Description	Node-ID (see chapter 6: Parameter description ⇒ parameter no. 22)
Access	read
PDO mapping	no
Data type	Unsigned8
Default	1
EEPROM	yes
Value range	1 ... 127

### 7.12.2.33 2102<sub>n</sub>: Gear reduction

The gear reduction of the AG03/1 can be read out via object 2102<sub>n</sub>.

Subindex	00 <sub>h</sub>
Description	Gear reduction
Access	read
PDO mapping	no
Data type	Unsigned8
Default	no
EEPROM	no
Value range	2 ... 3

#### Data description:

Value = 2: Gear reduction 24:1  
 Value = 3: Gear reduction 48:1

### 7.12.2.34 2410<sub>h</sub>: Motor Parameter Set

Object 2410<sub>h</sub> contains all adjustable control parameters of the drive controller.

Subindex	00 <sub>h</sub>
Description	largest sub-index supported
Access	read-only
PDO mapping	no
Data type	Unsigned8
Default	0Ah
EEPROM	no

Subindex	01 <sub>h</sub>
Description	Controller parameter P (see chapter 6: Parameter description ⇒ parameter no. 1)
Access	read-write
PDO mapping	no
Data type	Unsigned16
Default	100
EEPROM	yes
Value range	1 ... 500

Subindex	02 <sub>h</sub>
Description	Controller parameter I (see chapter 6: Parameter description ⇒ parameter no. 2)
Access	read-write
PDO mapping	no
Data type	Unsigned16
Default	5
EEPROM	yes

Subindex	03 <sub>h</sub>
Description	Controller parameter D (see chapter 6: Parameter description ⇒ parameter no. 3)
Access	read-write
PDO mapping	no
Data type	Unsigned16
Default	0
EEPROM	yes
Value range	0 ... 500

Subindex	04 <sub>h</sub>
Description	a- Pos (acceleration positioning mode) (see chapter 6: Parameter description ⇒ parameter no. 4)
Access	read-write
PDO mapping	no
Data type	Unsigned8
Default	50
EEPROM	yes
Value range	1 ... 100

Subindex	05 <sub>h</sub>
Description	v- Pos (velocity positioning mode) (see chapter 6: Parameter description ⇒ parameter no. 5)
Access	read-write
PDO mapping	no
Data type	Unsigned8
Default	30
EEPROM	yes
Value range	Gear 24:1 ⇒ 1 ... 200 Gear 48:1 ⇒ 1 ... 100

Subindex	06 <sub>h</sub>
Description	a – Rot (acceleration velocity mode) (see chapter 6: Parameter description ⇒ parameter no. 5)
Access	read-write
PDO mapping	no
Data type	Unsigned8
Default	50
EEPROM	yes
Value range	1 ... 100

Subindex	08 <sub>h</sub>
Description	a – Inch (acceleration inching operation) (see chapter 6: Parameter description ⇒ parameter no. 8)
Access	read-write
PDO mapping	no
Data type	Unsigned8
Default	50
EEPROM	yes
Value range	1 ... 100

Subindex	09 <sub>h</sub>
Description	v – Inch (velocity inching operation) (see chapter 6: Parameter description ⇒ parameter no. 9)
Access	read-write
PDO mapping	no
Data type	Unsigned8
Default	30
EEPROM	yes
Value range	Gear 24:1 ⇒ 1 ... 200 Gear 48:1 ⇒ 1 ... 100

Subindex	0A <sub>h</sub>
Description	d – Pos (delay in positioning operation) (see chapter 6: Parameter description ⇒ parameter no. 31)
Access	read-write (read enable in the “Pre-Operational“ and “Operational“ states, read disable with active travel job)
PDO mapping	no
Data type	Unsigned8
Default	101
EEPROM	yes
Value range	1 ... 101

### 7.12.2.35 2412<sub>h</sub>: Spindle Pitch

Spindle pitch is set via object 2412<sub>h</sub>.

Subindex	00 <sub>h</sub>
Description	Spindle pitch (see chapter 6: Parameter description ⇒ parameter no. 13)
Access	read-write
PDO mapping	no
Data type	Unsigned16
Default	0
EEPROM	yes
Value range	0 ... 1000

### 7.12.2.36 2413<sub>h</sub>: Pos Type

The positioning type is set via object 2413<sub>h</sub>.

Subindex	00 <sub>h</sub>
Description	Positioning type (see chapter 6: Parameter description ⇒ parameter no. 19)
Access	read-write
PDO mapping	no
Data type	Unsigned8
Default	0
EEPROM	yes
Value range	0 ... 2

#### Data description:

Value = 0: direct  
 Value = 1: loop +  
 Value = 2: loop –

### 7.12.2.37 2415<sub>h</sub>: Delta Jog

The travel distance in inching operation 1 is set via object 2415<sub>h</sub>.

Subindex	00 <sub>h</sub>
Description	Travel distance inching operation 1 (see chapter 6: Parameter description ⇒ parameter no. 17)
Access	read-write
PDO mapping	no
Data type	Integer32
Default	1600
EEPROM	yes
Value range	- 1000000 ... + 1000000



### 7.12.2.38 2416<sub>h</sub>: Stop Mode Inching Mode 2

The stop behaviour in inching mode 2 is set via object 2416<sub>h</sub>.

Subindex	00 <sub>h</sub>
Description	stop mode inching 2 (see chapter 6: Parameter description ⇒ parameter no. 25)
Access	read-write
PDO mapping	no
Data type	Unsigned8
Default	0
EEPROM	yes
Value range	0-1

### 7.12.2.39 2417<sub>h</sub>: Inpos Mode

The drive's behaviour when reaching the positioning window is defined by object 2417<sub>h</sub>.

Subindex	00 <sub>h</sub>
Description	Inpos Mode (see chapter 6: Parameter description ⇒ parameter no. 26)
Access	read-write
PDO mapping	no
Data type	Unsigned8
Default	0
EEPROM	yes
Value range	0-2

### 7.12.2.40 2418<sub>h</sub>: Loop Length

Loop length is determined by Object 2418<sub>h</sub>.

Subindex	00 <sub>h</sub>
Description	Loop Length (see chapter 6: Parameter description ⇒ parameter no. 27)
Access	read-write
PDO mapping	no
Data type	Unsigned16
Default	800
EEPROM	yes
Value range	0-10000

### 7.12.2.41 241B<sub>h</sub>: Power Supply Voltage

Object 241B<sub>h</sub> contains the supply voltages.

Subindex	00 <sub>h</sub>
Description	Largest sub-index supported
Access	read-only
PDO mapping	no
Data type	Unsigned8
Default	2
EEPROM	no

Subindex	01 <sub>h</sub>
Description	Supply voltage of the output stage in 1/10 V
Access	read-only
PDO mapping	no
Data type	Unsigned16
Default	no
EEPROM	no

Subindex	02 <sub>h</sub>
Description	Supply voltage of the control in 1/10 V
Access	read-only
PDO mapping	no
Data type	Unsigned16
Default	no
EEPROM	no

#### 7.12.2.42 241C<sub>h</sub>: Output Stage Temperature

Object 241C<sub>h</sub> contains the output stage temperature.

Subindex	00 <sub>h</sub>
Description	Output stage temperature in 1/10 °C
Access	read-only
PDO mapping	no
Data type	Integer16
Default	no
EEPROM	no

#### 7.12.2.43 241E<sub>h</sub>: Motor Current

Object 241E<sub>h</sub> contains the current motor current.

Subindex	00 <sub>h</sub>
Description	Motor current in mA
Access	read-only
PDO mapping	no
Data type	Integer16
Default	no
EEPROM	no

#### 7.12.2.44 2420<sub>h</sub>: Generic Status Register

Via object 2420<sub>h</sub> the states of supply voltage of the output stage and of torque disable can be read.

Subindex	00 <sub>h</sub>
Description	states of torque disable and of supply voltage of the output stage
Access	read
PDO mapping	no
Data type	Unsigned8
Default	no
EEPROM	no

Format description:

Bit 7	State of torque deactivation 0 = inactive 1 = active
Bit 4	State of supply voltage of the output stage 0 = Supply voltage of the output stage is not applied 1 = Supply voltage of the output stage is applied
Bit 0 - 3 ; 5 - 6	not used

#### 7.12.2.45 2421<sub>h</sub>: Torque Deactivation

Torque deactivation is set via object 2421<sub>h</sub>.

Subindex	00 <sub>h</sub>
Description	Torque deactivation (see chapter 6: Parameter description ⇒ parameter no. 29)
Access	read-write
PDO mapping	no
Data type	Unsigned8
Default	125
EEPROM	yes
Value range	20-125

#### 7.12.2.46 2422<sub>h</sub>: Torque Deactivation State

The state of torque deactivation can be read via object 2422<sub>h</sub>.

Subindex	00 <sub>h</sub>
Description	State of torque deactivation
Access	read
PDO mapping	no
Data type	Unsigned8
Default	no
EEPROM	no

Format description:

Bit 1-7	not used
Bit 0	State of torque deactivation 0 = inactive 1 = active

#### 7.12.2.47 2423<sub>h</sub>: Battery Voltage

Object 2423<sub>h</sub> contains the current battery voltage.

Subindex	00 <sub>h</sub>
Description	Battery voltage in 1/100 V
Access	read-only
PDO mapping	no
Data type	Integer16
Default	no
EEPROM	no

### 7.12.2.48 2450<sub>h</sub>: Inching 2 Offset

Via object 2450<sub>h</sub> an offset value can be set in inching operation 2.

Subindex	00 <sub>h</sub>
Description	Offset value in inching operation 2 (see chapter 6: Parameter description ⇒ parameter no. 30)
Access	read-write (write enable in states "Pre-Operational" and "Operational")
PDO mapping	no
Data type	Unsigned8
Default	100
EEPROM	no
Value range	10 ... 100

### 7.12.2.49 2500<sub>h</sub>: Production Date

Object 2500<sub>h</sub> indicates the production date.

Subindex	00 <sub>h</sub>
Description	date of production in readable hex notation
Access	read-only
PDO mapping	no
Data type	Unsigned32
Default	no
EEPROM	yes

Format description (example):

15 07 20 09<sub>h</sub> = 15.07.2009 = DDMMJJJJ

### 7.12.2.50 6040<sub>h</sub>: Control word

The object 6040<sub>h</sub> is the control word of the state machine for drives according to the device profile CiA DSP-402.

Subindex	00 <sub>h</sub>
Description	control word
Access	read-write
PDO mapping	yes
Data type	Unsigned16
Default	no
EEPROM	no

Format description:

see chapter 7.5: Control word

PDO mapping:

The control word is mapped on the three Receive PDOs (see objects 1600<sub>h</sub> – 1603<sub>h</sub>).

### 7.12.2.51 6041<sub>h</sub>: Status word

The object 6041<sub>h</sub> is the status word of the state machine for drives according to the device profile CiA DSP-402.

Subindex	00 <sub>h</sub>
Description	Status word
Access	read-only
PDO mapping	yes
Data type	Unsigned16
Default	no
EEPROM	no

Format description:

see chapter 7.4: Status word

PDO mapping:

The status word is mapped on the three Transmit PDOs (see objects 1A00<sub>h</sub> – 1A03<sub>h</sub>).

### 7.12.2.52 6060<sub>h</sub>: Modes of Operation

The operation mode of the AG03/1 is set via object 6060<sub>h</sub>.

Subindex	00 <sub>h</sub>
Description	Operating mode (see chapter 6: Parameter description ⇒ parameter no. 20)
Access	read-write
PDO mapping	no
Data type	Unsigned8
Default	1
EEPROM	yes
Value range	1 ... 2

Data description

Value = 1: Profile Position Mode (positioning mode)

Value = 2: Profile Velocity Mode (velocity mode)

### 7.12.2.53 6064<sub>h</sub>: Position Actual Value

Object 6064<sub>h</sub> contains the actual position value in the Profile Position Mode (positioning mode).

Subindex	00 <sub>h</sub>
Description	absolute position value in the positioning mode
Access	read-only
PDO mapping	yes
Data type	Integer32
Default	no
EEPROM	no

PDO mapping:

The absolute position value and the status word of the state machine are mapped on the Transmit PDO3, see object 1A02<sub>h</sub> (3<sup>rd</sup> Transmit PDO mapping parameter).

### 7.12.2.54 6067<sub>h</sub>: Position Window

A symmetric range of tolerable positions for standstill monitoring in the target point of positioning is set via object 6067<sub>h</sub>.

Subindex	00 <sub>h</sub>
Description	Pos- window (see chapter 6: Parameter description ⇒ parameter no. 10)
Access	read-write
PDO mapping	no
Data type	Unsigned16
Default	10
EEPROM	yes
Value range	0 ...1000

### 7.12.2.55 606C<sub>h</sub>: Velocity Actual Value

Object 606C<sub>h</sub> contains the actual velocity in the Profile Velocity Mode (velocity mode).

Subindex	00 <sub>h</sub>
Description	Actual velocity in velocity mode
Access	read-only
PDO mapping	yes
Data type	Integer32
Default	no
EEPROM	no

PDO mapping:

The actual velocity and the status word of the state machine are mapped on the Transmit PDO4, see object 1A03<sub>h</sub> (4<sup>th</sup> Transmit PDO mapping parameter).

### 7.12.2.56 607A<sub>h</sub>: Target Position

The target position of a drive movement in the operation mode Profile Position Mode (position mode) is entered via object 607A<sub>h</sub>.

Subindex	00 <sub>h</sub>
Description	setpoint in the positioning mode
Access	read-write
PDO mapping	yes
Data type	Integer32
Default	no
EEPROM	no
Value range	± 9999999

PDO mapping:

The target position and the control word of the state machine are mapped on the Receive PDO3, see object 1602<sub>h</sub> (3<sup>rd</sup> Receive PDO mapping parameter).

### 7.12.2.57 607C<sub>h</sub>: Calibration Value

The calibration value is programmed and the programmed calibration value taken over as the absolute position value via object 607C<sub>h</sub>.

Subindex	00 <sub>h</sub>
Description	Calibration value (see chapter 6: Parameter description ⇒ parameter no. 14 and chapter 3: Calibration)
Access	read-write
PDO mapping	no
Data type	Integer32
Default	0
EEPROM	yes
Value range	± 999999

### 7.12.2.58 607D<sub>h</sub>: Software Position Limit

Via object 607D<sub>h</sub>, the software limit switches defining the working range of the drive are set.

Subindex	00 <sub>h</sub>
Description	Number of subindexes
Access	read-only
PDO mapping	no
Data type	Integer32
Default	2
EEPROM	no

Subindex	01 <sub>h</sub>
Description	Limit 2 (see chapter 6: Parameter description ⇒ parameter no. 16)
Access	read-write
PDO mapping	no
Data type	Integer32
Default	-1000000
EEPROM	yes
Value range	± 9999999

Subindex	02 <sub>h</sub>
Description	Limit 1 (see chapter 6: Parameter description ⇒ parameter no. 15)
Access	read-write
PDO mapping	no
Data type	Integer32
Default	+1000000
EEPROM	yes
Value range	± 9999999

### 7.12.2.59 607E<sub>h</sub>: Polarity

The polarity of the drive's sense of rotation is set via object 607E<sub>h</sub>.

Subindex	00 <sub>h</sub>
Description	Sense of rotation (see chapter 6: Parameter description ⇒ parameter no. 18)
Access	read-write
PDO mapping	no
Data type	Unsigned8
Default	0
EEPROM	yes
Value range	0 ... 1

#### Data description

Value '0' = sense of rotation 'i'  
Value '1' = sense of rotation 'e'

### 7.12.2.60 6091<sub>h</sub>: Gear Ratio

A gear ratio can be programmed via object 6091<sub>h</sub>.

Subindex	00 <sub>h</sub>
Description	Number of subindexes
Access	read-only
PDO mapping	no
Data type	Unsigned16
Default	2
EEPROM	no

Subindex	01 <sub>h</sub>
Description	Numerator gear ratio (see chapter 6: Parameter description ⇒ parameter no. 11)
Access	read-write
PDO mapping	no
Data type	Unsigned16
Default	1
EEPROM	yes
Value range	1 ... 10000

Subindex	02 <sub>h</sub>
Description	Denominator gear ratio (see chapter 6: Parameter description ⇒ parameter no. 12)
Access	read-write
PDO mapping	no
Data type	Unsigned16
Default	1
EEPROM	yes
Value range	1 ... 10000

see also chapter 4: External gear unit.



### 7.12.2.61 60FF<sub>h</sub>: Target Velocity

The target velocity of a drive movement in the operation mode Profile Velocity Mode (velocity mode) is entered via object 60FF<sub>h</sub>.

Subindex	00 <sub>h</sub>
Description	Target velocity in the velocity mode of operation
Access	read-write
PDO mapping	yes
Data type	Integer32
Default	no
EEPROM	no
Value range	Gear 24:1 ⇒ ± 200 Gear 48:1 ⇒ ± 100

#### PDO mapping:

The target velocity and the control word of the state machine are mapped on the Receive PDO4, see object 1603<sub>h</sub> (4<sup>th</sup> Receive PDO mapping parameter).

### 7.13 Setting the node address of the AG03/1.

The node address can only be set via DIP switches.

The 10-pin DIP switch will be visible after removing the cover.

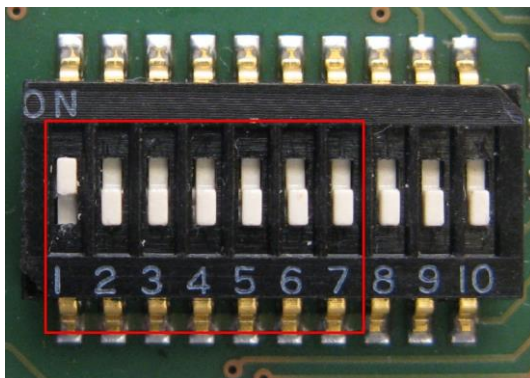

The node address is entered via switches 1 – 7 in binary format. The setting of address 0 is internally set into address 1.

This is illustrated in the following table:

SW1 [2 <sup>0</sup> ]	SW2 [2 <sup>1</sup> ]	SW3 [2 <sup>2</sup> ]	SW4 [2 <sup>3</sup> ]	SW5 [2 <sup>4</sup> ]	SW6 [2 <sup>5</sup> ]	SW7 [2 <sup>6</sup> ]	Set slave address
OFF	OFF	OFF	OFF	OFF	OFF	OFF	1!
ON	OFF	OFF	OFF	OFF	OFF	OFF	1
OFF	ON	OFF	OFF	OFF	OFF	OFF	2
ON	ON	OFF	OFF	OFF	OFF	OFF	3
:	:	:	:	:	:	:	:
OFF	OFF	ON	ON	ON	ON	ON	124
ON	OFF	ON	ON	ON	ON	ON	125
OFF	ON	ON	ON	ON	ON	ON	126
ON	ON	ON	ON	ON	ON	ON	127

<b>NOTICE</b>	The DIP switch settings are only read when the supply voltage is switched on. Changing the slave address during operation has no effect.
---------------	--

## 7.14 Diagnosis LEDs

Various operational states are signalled via the diagnosis LEDs.

	State	Meaning
<b>Status LED (green)</b>	blinking	Drive out of order, meaning: see chapter 5.2.1
	ON	The supply voltages of the output stage and control are applied
	OFF	The supply voltages of the output stage and control are missing
<b>BUS LED (orange)</b>	blinking 2,5 Hz	Drive is in the pre-operational mode
	ON	Drive is in the operational mode
	blinking (scan ratio 1:5)	Drive is in the stopped mode

## 7.15 CAN bus termination

The internal bus terminator can be switched in via DIP switches 9 + 10:

SW9	SW10	Bus terminator
OFF	OFF	deactivated
ON	ON	active

<b>NOTICE</b>	It should be noted that both DIP switches are always required for correct function of bus termination.
---------------	--