

# Hall Effect Sensors

## Models 906/906B & 907/907B

### Description

The 906 Standard and the 907 Explosionproof Hall Effect Sensors produce digital pulse signals for use with speed switches, tachometers, counters, signal conditioners, or as direct pulse input into programmable controllers. As a pulser disc or shaft wrap mounted on the monitored shaft rotates, the target magnets pass in front of the sensor. The Hall Effect sensor switches high and low as it is exposed to the alternating polarity of the magnets on the disc or wrap, which produces one pulse for every two magnets.

Both sensors allow a gap distance up to 1/2 inch between the surface of the sensor and the target magnets. The gap flexibility makes the sensors tolerant of vibration, slight shaft run-out, and minor misalignment. The 906/906B Sensor is waterproof and suitable for most applications, including environments where dirt, dust, grease, or moisture are present. The 907/907B Sensor is used in applications requiring explosionproof ratings, or in applications where the sensor may be subject to abuse.

The sensors can be mounted up to 1500 feet from the control unit, speed switch, tachometer, etc. They are powered by 5-25 VDC and provide an NPN Open Collector output. The 906/906B Standard Sensor has a threaded aluminum body and is supplied with a mounting bracket. The 907/907B Explosionproof Sensor has an XLB-3 enclosure which is C.S.A. approved and UL rated for Class I, Div 1, Group D; Class II, Div 1, Group E,F,G. The enclosure has a 1 inch NPT conduit opening and is provided with a mounting bracket.

### Pulser Disc

The end of the shaft to be monitored must be center drilled to a depth of 1/2 inch with a No. 21 drill and tapped for 10-32 UNF. After applying Loctite® or a similar adhesive on the threads to keep the pulser disc tight, the pulser disc should be attached decal side out with the supplied 10-32 UNF machine screw and lock washer. Discs can be used with either of the 906 or 907 sensors.

### Pulser Wrap

Pulser Wraps are custom manufactured to fit the shaft they will be mounted on. When the wrap is shipped, four Allen-head cap screws hold the two halves of the wrap together. These screws must be removed so that the wrap is in two halves. Place the halves around the shaft, reinsert the screws and torque them to 8 foot pounds. Pulser wraps can be used with either of the 906 or 907 sensors.

### Sensor Installation

The standard sensor is supplied with a mounting bracket and two jam nuts. The explosionproof sensor is supplied with a slotted mounting bracket. Sensors should be installed so the center line of the magnets pass in front of the center of the sensor as the disc or wrap rotates. When using the pulser disc, the center of the magnetized area of the disc, shown as Dimension B in figures 1 and 3, is 1-3/4 inches from the center hole of the disc.

The recommended gap distance between the sensor and the disc or wrap, Dimension A in the diagrams, is 1/4 inch +/- 1/8 inch. To achieve the

6111 Blue Circle Drive  
 Minnetonka, MN 55343  
 Phone: 952.930.0100  
 Fax: 952.930.0130  
 ISO 9001:2000 Certified



proper gap distance, adjust the jam nuts holding the standard sensor in the mounting bracket, or adjust the position of the explosionproof sensor using the slots on its mounting bracket.

**Important:** A line has been scribed on the face of the 906B and 907B sensor. The sensor must be positioned so that the magnets pass down that line (the center line of the magnets and the line scribed on the sensor must be parallel with each other). See illustration below.

**Note:** If your device reads in the wrong direction, reverse the sensor A and sensor B leads.

### Electrical Connections

The 906 and 907 sensors are designed for use with devices that have an internal pull-up resistor. If the device receiving the signal from the sensor does not have a pull-up resistor, a 2.2 KOhm resistor must be placed between the sensor supply voltage and the sensor signal output.

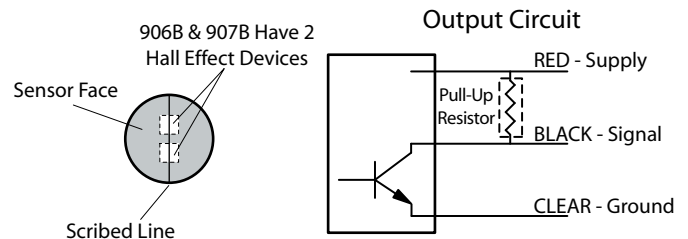

**Note:** Exercise caution when wiring the sensor. Damage will occur if the SIGNAL and SUPPLY wires are shorted.

Color	Connect To	Description
Shield	Circuit Ground	Transducer Shield
White or Clear	Circuit Ground	Transducer Ground
Red	Supply	Transducer supply Voltage
Black	Sensor A	Signal A
Green	Sensor B	Signal B (906B/907B Only)

Free Catalog and Application Assistance  
 1.800.328.6170  
 Visit Us Online  
 www.electro-sensors.com  
 990-001600 Revision C

## 906/906B Specifications

Supply	5-25 Vdc @ 10 mA
Output Type	NPN Open Collector
Current sink	25 mA Max
Max Frequency	20 kHz
Temp Range	-40° C to +60° C
Gap Distance	1/4 inch +/- 1/8 inch
Max Cable Length	1500 feet
Body Material	Aluminum
Cable	3-Conductor, Shielded
Mounting Bracket	Plated Steel, Included

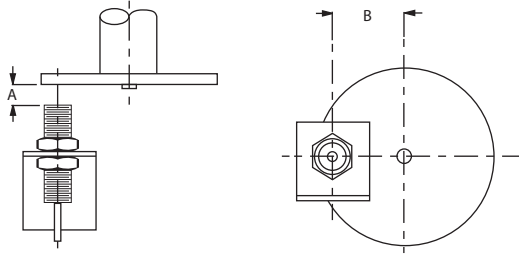

Figure 1: 906 and Pulser Disc

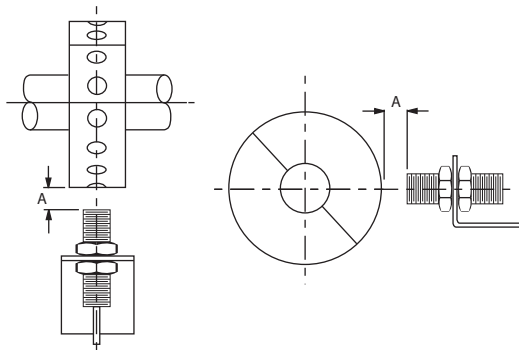
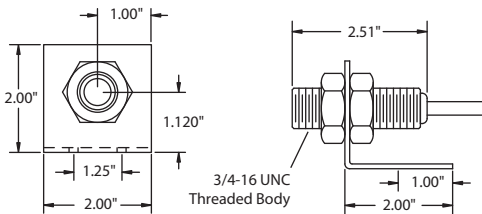

Figure 2: 906 and Pulser Wrap

## Part Dimensions

### 906/906B Sensor



### Mounting Bracket

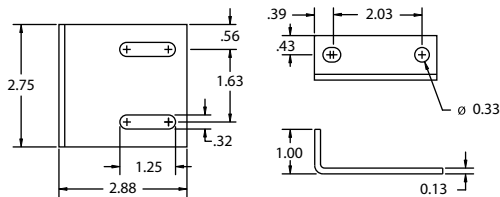

## 907/907B Specifications

Supply	5-25 Vdc @ 10 mA
Output Type	NPN Open Collector
Current sink	25 mA Max
Max Frequency	20 kHz
Temp Range	-40° C to +65° C
Gap Distance	1/4 inch +/- 1/8 inch
Max Cable Length	1500 feet
Cable	3-Conductor, Shielded
Mounting Bracket	Plated Steel U-Bolt assembly, Included



Class I, Div 1, Group D  
Class II, Div 1, Groups E, F, G  
UL File: E249019

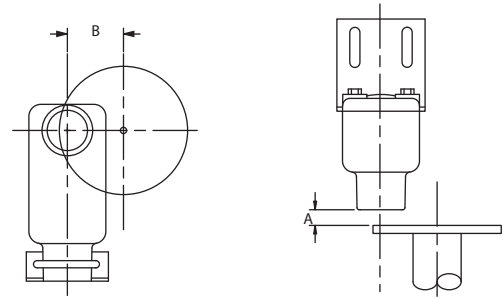

Figure 3: 907 and Pulser Disc

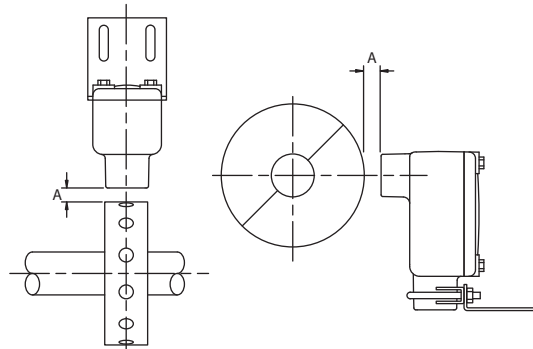

Figure 4: 907 and Pulser Wrap

### 907/907B Sensor

